

Planar UltraRes™ User Manual

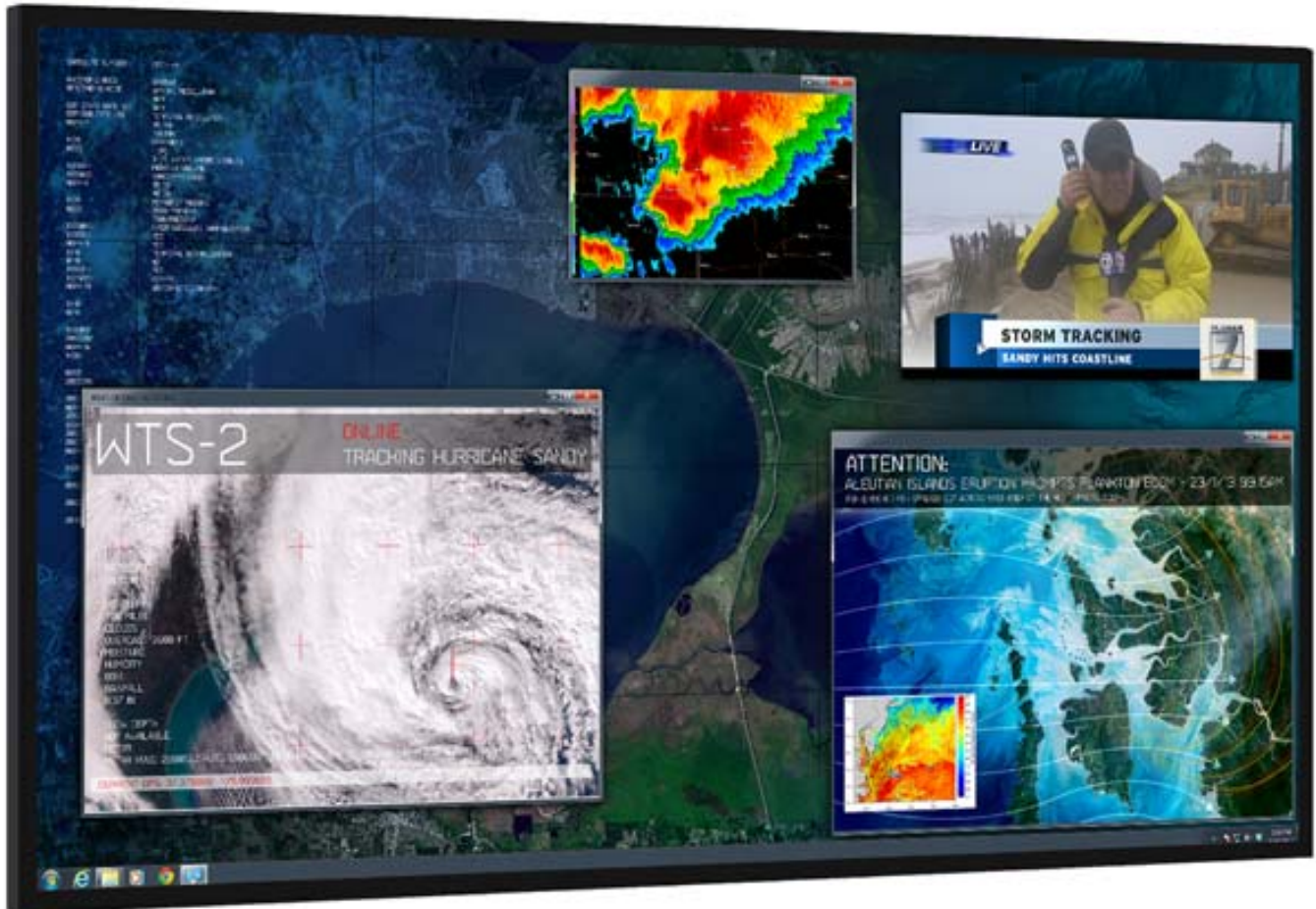

PLANAR
TM

Copyright © 2015 by Planar Systems, Inc. All rights reserved.

Contents of this publication may not be reproduced in any form without permission of Planar Systems, Inc.

Trademark Credits

Windows™ is a trademark of Microsoft Corp.

All other names are trademarks or registered trademarks of their respective companies.

Disclaimer

The information contained in this document is subject to change without notice. Planar Systems, Inc. makes no warranty of any kind with regard to this material. While every precaution has been taken in the preparation of this manual, the Company shall not be liable for errors or omissions contained herein or for incidental or consequential damages in connection with the furnishing, performance, or use of this material.

Warranty and Service Plans

Planar warranty and service plans will help you maximize your investment by providing great support, display uptime, and performance optimization. From post-sale technical support to a full suite of depot services, our services are performed by trained Planar employees. When you purchase a Planar product, you get more than a display, you get the service and support you need to maximize your investment. To find the latest warranty and service information regarding your Planar product, please visit <http://www.planarcontrolroom.com/support>

RoHS Compliance Statement

The Planar UltraRes 4K professional displays are fully RoHS compliant.

ADA Compliance Statement

All Planar UltraRes 4K professional displays are compliant with the Americans with Disabilities Act.

Part Number: 020-1229-03A

Contents

- Introduction 8
 - Important Safety Instructions9
- Recommended Usage 12
 - Burn-In Versus Temporary Image Retention 12
 - Normal Use Thermal Guidelines 13
 - Using the Display in Flat or Tilted Orientation..... 13
- Basic Concept of Planar UltraRes Display 14
- Using the Remote Control 15
- Powering On/Off Planar UltraRes Displays..... 16
 - Planar UltraRes in Standby Mode..... 17
- Input Setup 18
 - Supported Formats for Multiple Inputs 18

- Installing a Planar UltraRes Display 19
 - Before You Begin..... 19
 - Tools/Equipment List 19
 - Other Things You May Need 19
 - Plan Your Installation 19
 - Supported Graphics Cards 20
 - Setting Up AMD Graphics Cards For 3D Content 21
 - Setting Up NVIDIA Graphics Cards for 3D Content 22
 - Recommended PCs..... 23
 - Unpacking and Checking Accessories 24
 - LCD Module Box..... 24
 - Accessory Kit 26

- Installing the Displays..... 28
 - Installing an UltraRes Display on a Wall..... 29
 - Using the Lift Blocks (98" only) 36
 - Using the Kickstand Bracket..... 38

Connections	39
Connecting AC Power	39
Connecting the Wired IR Module.....	39
Connecting Sources	40
Setting up for Single Input Sources	40
Setting up for Multiple Input Sources	42
Setting up for 4K Support.....	46
Graphics Card Setup	50
AMD Graphics Card Setup for Quadrant Outputs	51
NVIDIA Graphics Card Setup for Single Output	53
NVIDIA Graphics Card Setup for Quadrant Output.....	59
Installing the UltraRes Control Software	61
Installing USB Drivers.....	64
Using the UltraRes Control Software	65
Setting Up Sources	67
Auto Power Off Timer	68
Standby Mode	68
Splash Screen	69
Order of Adjustment	70
Brightness	70
Contrast	70
Color Temperature	71
Gamma	71
EDID Type.....	72
HDMI 3D Frame Packing.....	72
Color Space	73
Gain	73
Offset.....	74
Changing Backlight Intensity	75
Turning Local Dimming On or Off.....	75

Changing Frame Delay	76
Upgrading Firmware	77
Error Log.....	79
Network Settings	80
DHCP Network Setup.....	80
Static IP Network Setup.....	82
Planar UltraRes Remote Monitoring Software	86
Remote Monitoring Home.....	86
Remote Monitoring Custom Commands	87
Remote Monitoring Unit Status	88
Remote Monitoring Display Control.....	89
Remote Monitoring Power On/Off.....	90
Remote Monitoring Source Setup.....	91
Remote Monitoring Advanced Setup.....	92
Remote Monitoring Custom Commands Setup.....	93
Remote Monitoring Admin Setup.....	93
Remote Monitoring Network Setup	94
Remote Monitoring Date and Time.....	95
Remote Monitoring Access Control.....	96
Remote Monitoring Software Setup (Upgrading Network Firmware)	97
Remote Monitoring Reboot.....	98
External Control	99
RS232 Communication	100
Connecting the RS232 Cable.....	100
Setting Up Multiple Inputs Using RS232 Commands	100
Setting Up Single Inputs Using RS232 Commands	101
RS232 Commands.....	102
RS232 Command Format	102

RS232 Response Format	103
RS232 Command/Response Examples	104
Supported UltraRes RS232 Commands	105
SNMP Monitoring	110
Sending RS232 Commands Via UDP	111
Using Discrete IR Codes	112
IR Command Protocol	112
Supported UltraRes IR Commands	113
Touchscreen Setup	114
USB and Power Hook-Up	114
Touchscreen MultiTouch Driver Installation	114
Touchscreen (PQLabs) MultiTouch Platform Content	115
Touchscreen Information	115
Calibration	115
Utility	115
Options	115
Uninstalling the MultiTouch Driver	115
Specifications	117
Signal Compatibility	120
UltraRes Dimensions	123
84" Display Dimensions - Front, Side and Top Views	123
84" Display Dimensions - Rear View	124
84" Rear View - Wall Mount Hangers and Service Panel Locations	125
84" Landscape Wall Mounts - Front and Bottom Views	126
84" Landscape Wall Mounts - Sides Views	127
84" Portrait Wall Mounts - Front View	128
84" Portrait Wall Mounts - Sides Views	129
84" UltraRes Touch - Front, Top and Bottom Views	130

84" UltraRes Touch - Side Views	131
84" UltraRes Touch - Rear View	132
98" Display Dimensions - Front, Side and Top Views	133
98" Display Dimensions - Rear View	134
98" Rear View - Wall Mount Hangers and Service Panel Locations	135
98" Landscape Wall Mounts - Front and Bottom Views	136
98" Landscape Wall Mounts - Sides Views	137
98" UltraRes Touch - Front, Top and Bottom Views	138
98" UltraRes Touch - Side Views	139
98" UltraRes Touch - Rear View	140
Troubleshooting During Installation	141
UltraRes LED Codes	141
Error Codes in the UltraRes Control Software	142
Symptoms, Possible Causes and Solutions	144
Symptom: Can't Get PC to Output 4K @ 24/30Hz	144
Symptom: Can't Get PC to Output 4K @ 60Hz	145
Symptom: My Scheduled Network Power On/Off Settings Aren't Working	146
Symptom: IR Isn't Working Properly	146
Accessing Planar's Technical Support Website	147
Downloading Additional Documentation and Firmware	147
Downloading Utility Software	147
Regulatory Information	148

Introduction

Planar UltraRes 4K professional display is a family of 84" and 98" Ultra HD displays that produce resolution and picture quality not before seen in large format LCD displays. Designed specifically for resolution-rich commercial applications, Planar UltraRes displays offer the image quality, connectivity, industrial design and configuration options required in leading control rooms, collaboration rooms and digital branding installations.

Some of the features of the UltraRes display are:

- Ultra HD (3840 x 2160) resolution
- Outstanding picture quality – 4x pixel density of a comparably-sized Full HD display
- Slim design with Planar Profile™ Mounting System (about 3" deep when mounted)
- Supports a range of 4K sources and timings
- Energy-saving features include LEDs, <0.5 watt standby mode and auto-off signal detection

Caution: This manual is intended for use by qualified service persons and end users with experience installing LCD displays

Important Safety Instructions

- 1 Read these instructions.
- 2 Keep these instructions.
- 3 Heed all warnings.
- 4 Follow all instructions.
- 5 Do not use any of the Planar UltraRes products near water.
- 6 Clean the LCD screens with an LCD screen cleaner or LCD wipes.
- 7 Do not install near any heat sources such as radiators, heat registers, stoves or other apparatus (including amplifiers) that produce heat.
- 8 Do not defeat the safety purpose of the polarized or grounding type plug. A polarized plug has two blades with one wider than the other. A grounding type plug has two blades and a third grounding prong. The wide blade or the third prong is provided for your safety. When the provided plug does not fit into your outlet, consult an electrician for the replacement of the obsolete outlet.
- 9 Protect the power cord from being walked on or pinched particularly at plugs, convenience receptacles and the point where they exit from any of the Planar UltraRes products.
- 10 Only use the attachments/accessories specified by the manufacturer.
- 11 Unplug all Planar UltraRes displays during lightning storms or when unused for long periods of time.
- 12 You must follow all National Electrical Code regulations. In addition, be aware of local codes and ordinances when installing your system.
- 13 Refer all servicing to qualified service personnel. Servicing is required when any of the Planar UltraRes products have been damaged in any way, such as the AC power cord or plug is damaged, liquid has been spilled or objects have fallen into a product, the products have been exposed to rain or moisture, do not operate normally or have been dropped.
- 14 Keep the packing material in case the equipment should ever need to be shipped.
- 15 Wall mounts must be secure. The wall must be strong enough to hold the UltraRes display, mounts and cables.
- 16 Slight pressure on the LCD will cause distortion of the image. Heavier pressure will cause permanent damage. Planar UltraRes configurations should be mounted where viewers cannot touch the screen or insert small objects in the openings that will create hazards by contacting bare conductive parts.

Caution: The front polarizer is soft and subject to scratches from sharp objects.

-
- 17** The polarizer is a thin sheet of film laminated to the outside layer of glass on the LCD screen. Take care when handling items near the screen.

European Disposal Information

English

- Disposal of old Electrical & Electronic Equipment (Applicable throughout the European Union and other European countries with separate collection programs)

This symbol found on your product or on its packaging, indicates that this product should not be treated as household waste when you wish to dispose of it. Instead, it should be handed over to an applicable collection point for the recycling of electrical and electronic equipment. By ensuring this product is disposed of correctly, you will help prevent potential negative consequences to the environment and human health, which could otherwise be caused by inappropriate disposal of this product. The recycling of materials will help to conserve natural resources.



This symbol is only valid in the European Union. If you wish to discard this product, please contact your local authorities or dealer and ask for the correct method of disposal.

Español

- Deshecho de equipos eléctricos y electrónicos (aplicable a la Unión Europea y a otros países europeos con programas de reciclaje independientes)

La presencia de este símbolo en el propio producto o en su material de embalaje, indica que no se debe tratar como residuo doméstico cuando deseé deshacerse de él. En su lugar, debe entregarlo en el punto limpio correspondiente de reciclaje de equipos eléctricos y electrónicos. Asegurándose de que este producto se desecha de forma correcta, ayudará a evitar posibles consecuencias negativas para la conservación del medioambiente y la salud humana, consecuencias que podrían darse si se desecha del producto de forma inadecuada. El reciclado de materiales ayuda a conservar los recursos naturales.



Este símbolo solamente es válido en la Unión Europea. Si desea deshacerse de este producto, póngase en contacto con las autoridades locales o con su distribuidor y pida información sobre el método de disposición adecuada.

Português

- Eliminação de equipamentos eléctricos e electrónicos usados (aplicável na União Europeia e noutros países europeus com programas próprios de recolha destes equipamentos)

Este símbolo, colocado no produto ou na respectiva embalagem, indica que o produto não deve ser tratado como lixo doméstico aquando da sua eliminação. Em vez disso, deve ser entregue num ponto de recolha de equipamentos eléctricos e electrónicos para posterior reciclagem. Ao garantir a correcta eliminação deste produto, estará a evitar consequências potencialmente negativas tanto para o ambiente como para a saúde humana. A reciclagem de materiais ajuda a preservar os recursos naturais.



Este símbolo apenas é válido na União Europeia. Se quiser eliminar este produto, contacte as entidades locais ou o seu fornecedor para ficar a saber qual o método de eliminação correcto.

Svenska

- Avfall av förbrukad elektrisk och elektronisk utrustning (Tillämpbart i hela Europeiska unionen och andra europeiska länder med separata samlingsprogram)

Den här symbolen som finns på din produkt eller på dess förpackning påvisar att produkten inte ska behandlas som hushållsavfall när du vill slänga bort den. Istället ska den lämnas över till en lämplig uppsamlingspunkt för återvinning av elektriska och elektroniska utrustningar. Genom att tillförsäkra att den här produkten återvinns på ett riktigt sätt hjälper du till med att förhindra möjliga negativa konsekvenser för miljön och mänsklig hälsa. Det kan annars orsakas på grund av olämplig sophantering av den här produkten. Återvinning av material kommer att hjälpa till att bevara naturtillgångar.



Den här symbolen är endast giltig inom den Europeiska unionen. Om du vill slänga bort den här produkten ska du kontakta lokala myndigheter eller återförsäljare, eller fråga efter lämplig avfallsmetod.

Français

- Mise au rebut des équipements électriques et électroniques usagés (Valable dans l'ensemble de l'Union Européenne ainsi que dans les pays européens disposant de programmes distincts de collecte des déchets)

Ce symbole appliqué sur votre produit ou sur son emballage indique que ce produit ne doit pas être traité comme un déchet ménager lorsque vous voulez le mettre au rebut. Il doit au contraire être remis à un site de collecte agréé pour le recyclage des équipements électriques et électroniques. En veillant à ce que ce produit soit mis au rebut de façon adéquate, vous contribuerez à prévenir les conséquences potentiellement négatives sur l'environnement et sur la santé humaine qui risqueraient de se produire en cas de mise au rebut inappropriée de ce produit. Le recyclage des matériaux contribuera également à économiser les ressources naturelles.



Ce symbole n'est valable que dans l'Union Européenne. Si vous souhaitez mettre ce produit au rebut, veuillez prendre contact avec les autorités locales ou avec votre revendeur et renseignez-vous sur la méthode de mise au rebut correcte.

Italiano

- Smaltimento delle attrezzature elettriche ed elettroniche usate (applicabile in tutta la Comunità Europea ed altri Paesi Europei che applicano programmi di raccolta differenziale)

Il simbolo trovato sul prodotto, o sulla sua confezione, indica che il prodotto non può essere trattato come i domestici quando è il momento di smaltirlo. Al contrario, deve essere consegnato ad un centro di raccolta specializzato nel riciclaggio di attrezzature elettriche ed elettroniche. Assicurando che il corretto smaltimento di questo prodotto, si aiuterà a prevenire potenziali conseguenze negative sull'ambiente e sulla salute umana, che possono essere provocate da uno scorretto smaltimento di questa attrezzatura. I materiali riciclati aiuteranno a conservare le risorse naturali.



Questo simbolo è valido solo nell'Unione Europea. Per smaltire questo prodotto, mettersi in contatto con le autorità locali - o con il rivenditore - e chiedere informazioni sul corretto metodo di smaltimento.

Polski

- Uzuwanie zużytego sprzętu elektrycznego i elektronicznego (Dotyczy krajów Unii Europejskiej i innych krajów europejskich z oddzielnymi programami zbiórki odpadów)

Obecność tego symbolu na produkcie lub na opakowaniu z produktem oznacza, że tego produktu nie można wyrzucać razem z odpadkami domowymi. Należy go przekazać do punktu zbiórki w celu poddania recyklingowi podzespołów elektrycznych i elektronicznych. Usunięcie tego produktu w prawidłowy sposób, pomoże w zabezpieczeniu przed negatywnym wpływem odpadów na środowisko i zdrowie ludzi, powodowanym przez niewłaściwe usuwanie produktu. Przetwarzanie materiałów pomaga w zachowaniu zasobów naturalnych.



Ten symbol obowiązuje wyłącznie w krajach Unii Europejskiej. Informacje dotyczące prawidłowej metody usunięcia tego produktu, można uzyskać u władz lokalnych lub u dostawcy.

Suomi

- Vanhoinen sähkö- ja elektroniikkalaitteiden hävittäminen (Soveltuvaa kaikkialla Euroopan unionin alueella, sekä muissa Euroopan maissa, joilla on erilliset keräysohjelmat)

Jos tuotteessa tai sen pakkauksessa on tämä symboli, sitä ei pidä hävittää tavallisena kotitalousjätteenä, vaan se kuuluu toimittamaan sähkö- ja elektroniikkalaitteiden kierrätyspisteeseen. Varmistamalla, että tämä tuote hävitetään asiaankuululla tavalla autat estämään mahdollisia ympäristölle ja ihmisille koituvia negatiivisia seuraamuksia, joita sen vääränlainen hävittäminen voi aiheuttaa. Materiaalien kierrättäminen auttaa säilyttämään luonnonvarjoja.



Tämä symboli on voimassa ainoastaan Euroopan unionin alueella. Jos haluat hävittää tämän tuotteen, ota yhteyttä paikallisiin viranomaisiin tai jälleenmyyjään ja tiedustele asiaankuuluvia hävittäistointenpiteitä.

Deutsch

- Entsorgung von elektrischen & elektronischen Altgeräten (geltend für die europäische Gemeinschaft und andere europäische Länder mit separaten Sammelprogrammen)

Dieses Symbol, zu finden auf Ihrem Produkt oder dessen Verpackung, macht Sie darauf aufmerksam, dass dieses Produkt bei der Entsorgung nicht als Hausmüll behandelt werden darf. Statt dessen sollte es an eine Sammelstelle zum Recycling von elektrischen und elektronischen Altgeräten gegeben werden. Helfen Sie mit, potenziell schädliche Einflüsse auf Umwelt und Gesundheit, die durch eine unsachgemäße Entsorgung dieses Produktes entstehen können, zu vermeiden und entsorgen Sie dieses Produkt ordnungsgemäß. Recycling hilft, natürliche Rohstoffe einzusparen.



Dieses Symbol ist nur innerhalb der europäischen Gemeinschaft gültig. Wenn Sie dieses Produkt entsorgen möchten, wenden Sie sich bitte an Ihre örtliche Behörde und fragen Sie nach der ordnungsgemäßen Entsorgungsmethode.

Nederlands

- Verwijderen van oude elektrische en elektronische apparatuur (toepasselijk in de volledige Europese Unie en andere Europese landen met afzonderlijke programma's voor afvalverzameling)

Dit symbool dat op het product of zijn verpakking is aangebracht, geeft aan dat dit product niet mag worden behandeld als huishoudelijk afval als u het wilt wegwerpen. U moet het afgeven bij een specifiek verzamelpunt voor de recycling van elektrische en elektronische apparatuur. Door te garanderen dat u dit product op de correcte manier wegwerpt, helpt u potentiële negatieve gevolgen voor het milieu en de menselijke gezondheid, die zouden kunnen worden veroorzaakt door een onrechtmatig wegwerpen van het product, te voorkomen. De recycling van materialen helpt het behoud van natuurlijke bronnen.



Dit symbool is alleen geldig in de Europese Unie. Als u dit product wenst weg te gooien, dient u contact op te nemen met uw lokale instanties voor details over de gepaste methode voor afvalverwijdering.

Waste Electrical and Electronic Equipment (WEEE) Directive In the European Union, this label indicates that this product should not be disposed of with household waste. It should be deposited at an appropriate facility to enable recovery and recycling. EEE complies with Directive 'Regulation on the Restriction of the Use of Certain Hazardous Substances in Electrical and Electronic Equipment'



Waste Electrical and Electronic Equipment (WEEE) Yönergeleri Avrupa Birliği'nde bu etiket, ürünün ev elektroniği atıkları ile imha edilemeyeceğini gösterir. Kurtarmak ve geri dönüşümünü sağlamak için uygun şartlarda saklanması gerekir. EEE Yönetmeliğine Uygundur Ve Elektronik Eşyalarda Bazı Zararlı Maddelerin Kullanımının Sınırlanmasında Dair Yönetmelik.



Recommended Usage

In order to get the most out of your LCD modules, use the following recommended guidelines to optimize the display.

Burn-In Versus Temporary Image Retention

Burn-in causes the screen to retain an image essentially forever, with little or no way to correct the problem. Under normal use, an LCD module will not experience burn-in, as plasma displays do, nor will it retain images in any way.

Normal use of an LCD module is defined as displaying continuously changing video patterns or images. However, LCD modules can experience *temporary* image retention when recommended usage guidelines are not followed.

What is Temporary Image Retention?

Temporary image retention (TIR) can occur when a static image is displayed continuously for extended periods of time. An electrical charge differential may build up between the electrodes of the liquid crystal, which causes a negative-color video image (color-inverted and brightness-inverted version of the previous image) to be retained when a new image is displayed. This behavior is true for any LCD device from any LCD manufacturer.

TIR is not covered under warranty. See standard warranty terms and conditions for details. Here are some guidelines to help you avoid TIR:

- Use the LCD module to show a screen saver, moving images or still pictures that change regularly. When using high-contrast images, reposition the images frequently.
- Turn off the Planar UltraRes when it is not in use.

Caution: For optimal performance, we suggest turning off the power on the Planar 84" UltraRes MX for 4 hours per day and 12 hours per day for the Planar 84" UltraRes LX and Planar 98" UltraRes.

Normal Use Thermal Guidelines

Normal use of the LCD module is defined as operating in the open air to prevent heat buildup, and without direct or indirect heat sources such as lighting fixtures, heating ducts, or direct sunlight that can cause the modules to experience high operating temperatures. If the LCD module will be installed in a recessed area with an LCD surround or enclosure, ensure adequate openings are applied for proper air flow and ventilation.

At 3000 meters or below, the maximum ambient operating temperature for the LCD module cannot be above 40° C nor below the minimum ambient operating temperature of 0° C. If one of these conditions exists, it is up to the installer to ensure that module placement is changed, thermal shielding is provided and/or additional ventilation is provided to keep the display within its nominal operating parameters.

Cooling Requirements

For optimal performance, active cooling by the installer should be planned for when the ambient temperature anywhere in the wall is predicted to be above the specified ambient temperature for the display.

Using the Display in Flat or Tilted Orientation

The Planar UltraRes is not recommended for use in flat orientation for tabletop, floor, or ceiling installations. LCD panels of this size are at risk of panel deflection, which can cause cosmetic sagging, brightness uniformity issues, a shortened life span, and malfunction of optional touch sensors. Installations where the display is tilted downward or upward at an angle may also be prone to these issues and are not recommended.

Basic Concept of Planar UltraRes Display

The Planar UltraRes display uses four internal outputs that feed into the display as one image. You can use any combination of HDMI/DVI or DisplayPort.

There are four main modes of operation for the UltraRes Display:

- Single 4K inputs @ 24/25/30Hz
- Single 4K inputs @ 50/60Hz (HDMI 4:2:0)
- Four-headed input (4K @ 60Hz)
- Two-headed input (4k @ 60Hz)

Using four internal outputs provides the Ultra HD resolution needed for superior image quality. In the following example, each number represents an output. All four “quadrants” (outputs) are fed into the display and turned into one ultra high-resolution image.

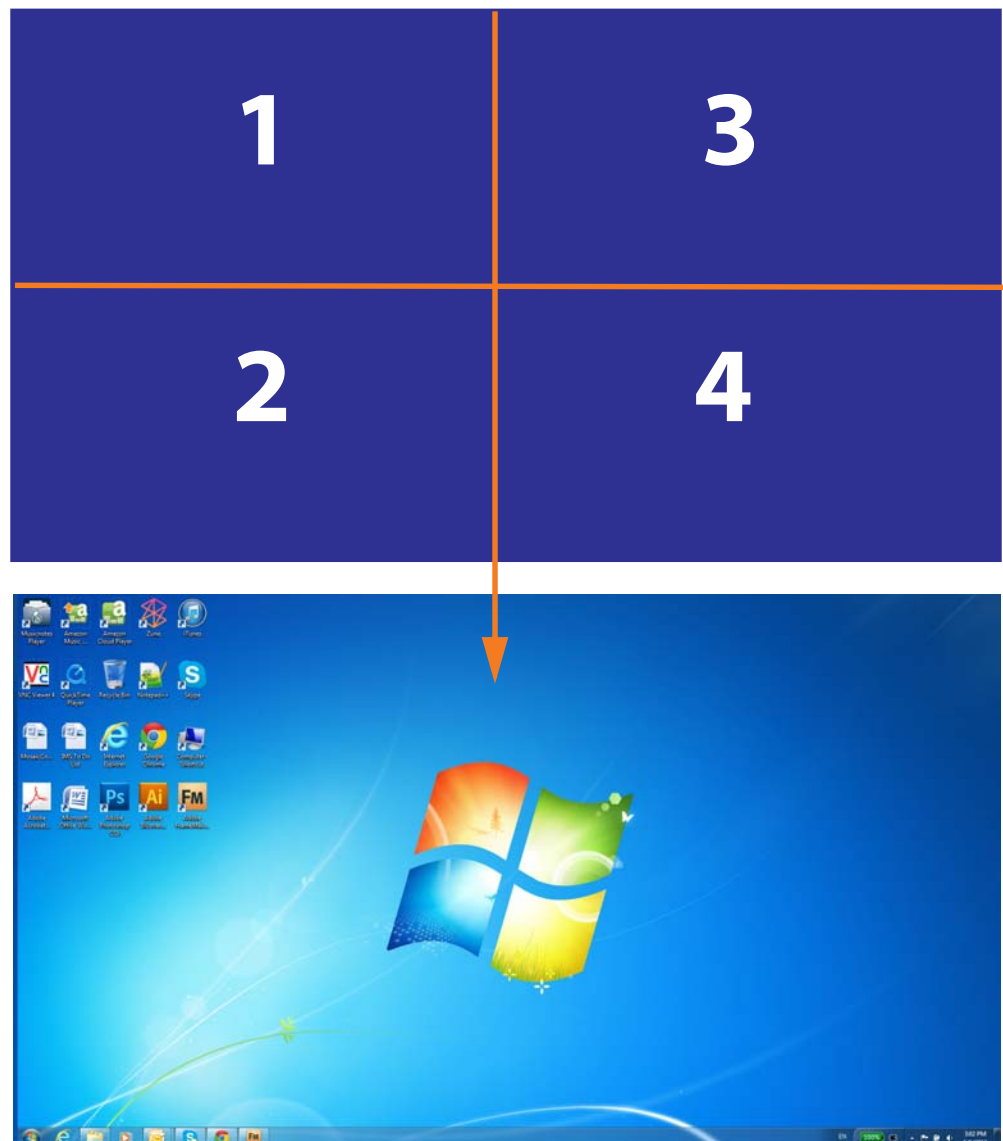

Using the Remote Control

The UltraRes remote control can be used for a variety of functions, including turning the display on and off and assigning individual inputs.

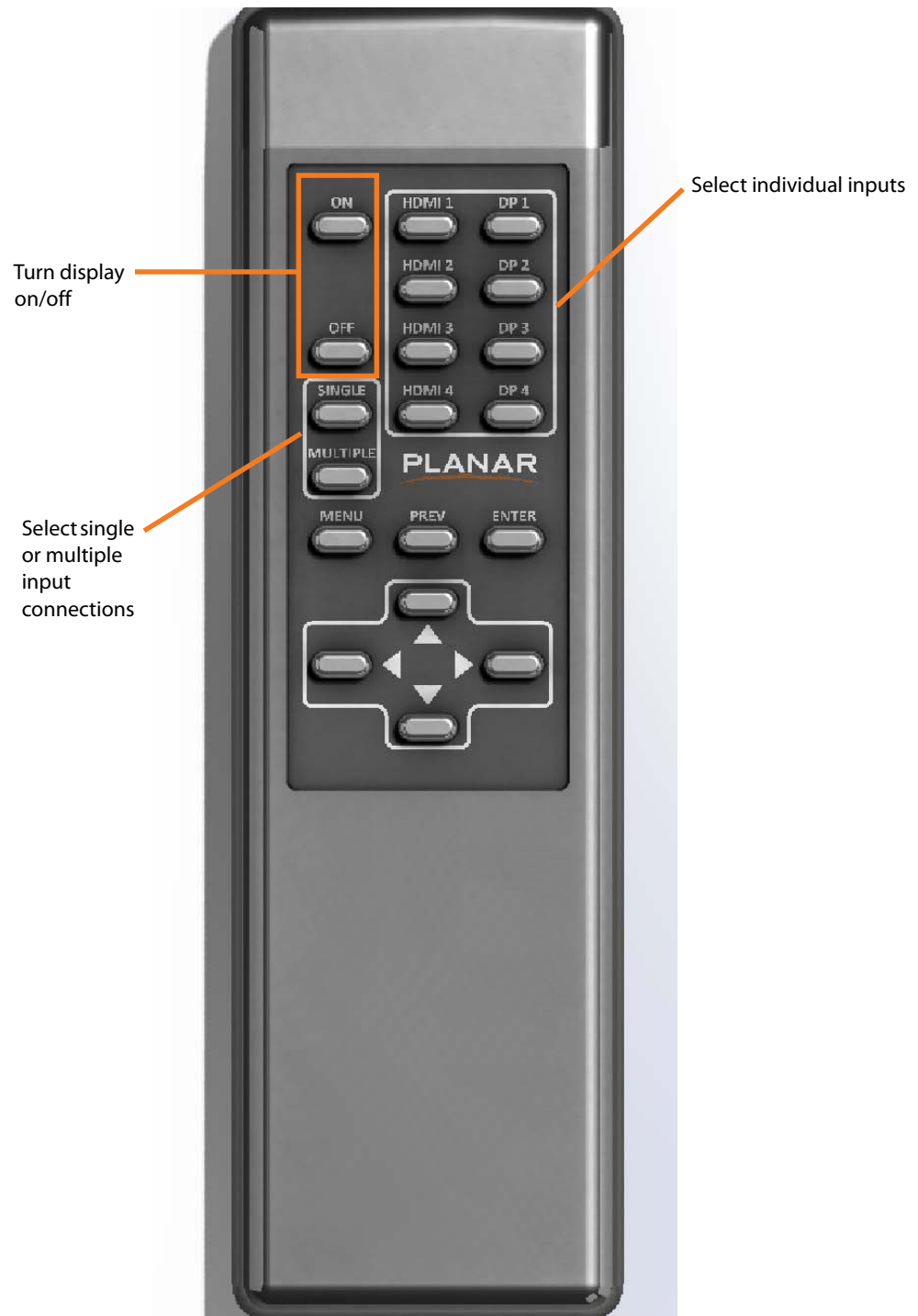

Powering On/Off Planar UltraRes Displays

There are several different ways to turn on or off the Planar UltraRes Display:

- Using the **On/Off** buttons on the remote control. See "Using the Remote Control" on page 15 for more information.
- Using the **Power On/Power Off** buttons in the UltraRes Control software tool. See "Using the UltraRes Control Software" on page 65 for detailed information about the UltraRes Control software.

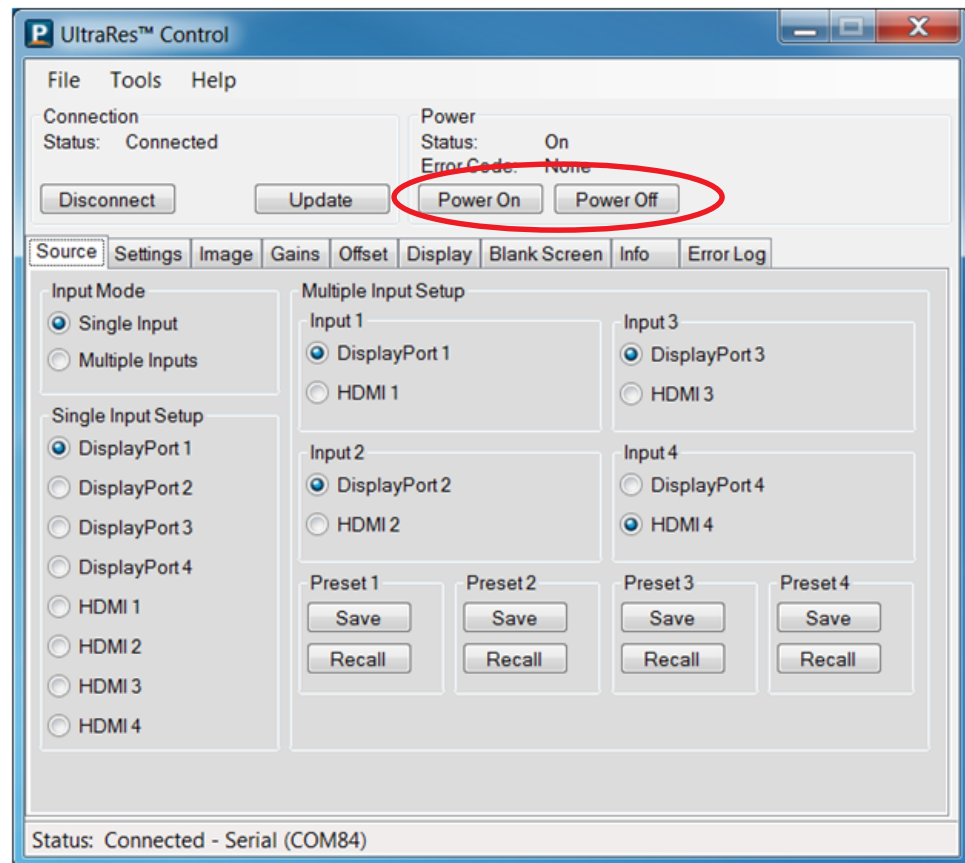

- Use the UltraRes Remote Monitoring software. See "Planar UltraRes Remote Monitoring Software" on page 86.

Planar UltraRes in Standby Mode

If you are unsure about whether or not the display is on but in standby mode, look for the small Standby LED. If it is off, you will not see the LED. If it is on but in Standby mode, you will see a blue LED. As the display starts, the LED blinks until the display is seen. Once it is there, the LED turns off.



Insert IR sensor cord into the IR input located on the I/O panel this side.

Input Setup

You can set up your Planar UltraRes display using multiple or single inputs. Both are explained below. You can select multiple or single input mode using the remote control, the UltraRes Control tool or by using RS232 commands. For more information see "Setting up for Multiple Input Sources" on page 42 and "Setting up for Single Input Sources" on page 40.

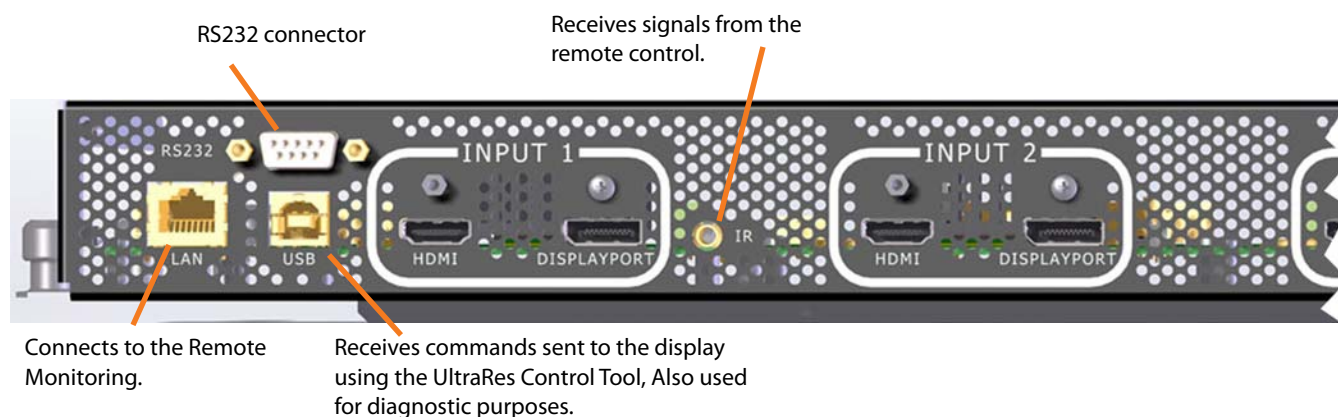

Supported Formats for Multiple Inputs

The following formats are supported for multiple inputs:

Quadrants or Single Inputs:

- 4K @ 24/25/30Hz
- 4K @ 50/60Hz (HDMI 4:2:0)
- 1080p @ 24/25/30/50/60Hz
- 1080i @ 50/60Hz
- 720p @ 50/60Hz

Swaths & Halves

- 960x2160 @ 60Hz
- 1920x2160 @ 60Hz, using inputs 1 & 3 or 2 & 4

Installing a Planar UltraRes Display

This section explains how to install a Planar UltraRes display. We suggest that you read this entire section before you attempt to install a display.

Before You Begin

Make sure you have all the items in the following lists before you begin unpacking and installing your display.

Tools/Equipment List

Depending on your installation, you may need one or more of the following items:

- #1 and # 2 Phillips screwdriver
- Drill and bits
- Pencil
- Digital/laser level
- Ladders/lift
- Back brace
- Stud finder (if hanging on a wall)

Other Things You May Need

- LCD screen cleaner or LCD wipes - available at most electronics stores
- Three strong people to lift display into place
- A mechanical lift device

Plan Your Installation

You should have a detailed plan of how the Planar UltraRes display is to be configured. The plan should include calculations for the following:

- Floor/wall load. Make sure the floor/wall is strong enough to support the weight of the Planar UltraRes.
- For passive cooling, it is recommended that a minimum of 1" of top clearance is provided. This can be reduced if the LCD is actively cooled.
- Ventilation and cooling requirements. Although the rear cover of the display is perforated and provides better airflow than other displays, it is still important that you consider room cooling and ventilation.

Supported Graphics Cards

UltraRes supports a variety of graphics cards from leading manufacturers, such as NVIDIA and AMD. In general, you should be looking for graphics cards that have the following features:

- Can output 3840 x 2160 at 24 Hz or 30 Hz over a single DisplayPort or HDMI connection.
- Four-output graphics cards that can output synchronized (genlocked) 1920 x 1080 outputs at up to 60 Hz.
- Each program will have application-specific 3D settings that must be set up. See the specific program's user manual for instructions on application-specific 3D setup.

Note: Consult the specific graphics card's user manual for instructions on application-specific 3D setup.

- Cards that support Planar's support timings, as listed in the following section "Signal Compatibility" on page 120.

Caution: Before you purchase a graphics card for your source, contact your Sales Representative to get the most current information on Planar's compatibility with leading graphics cards.

The following professional grade graphics cards support 3D capabilities:

- AMD FirePro W7000, W8000, W9000
- NVIDIA Quadro K5000

Setting Up AMD Graphics Cards For 3D Content

Note: If you do not plan to display 3D content, you can skip this section.

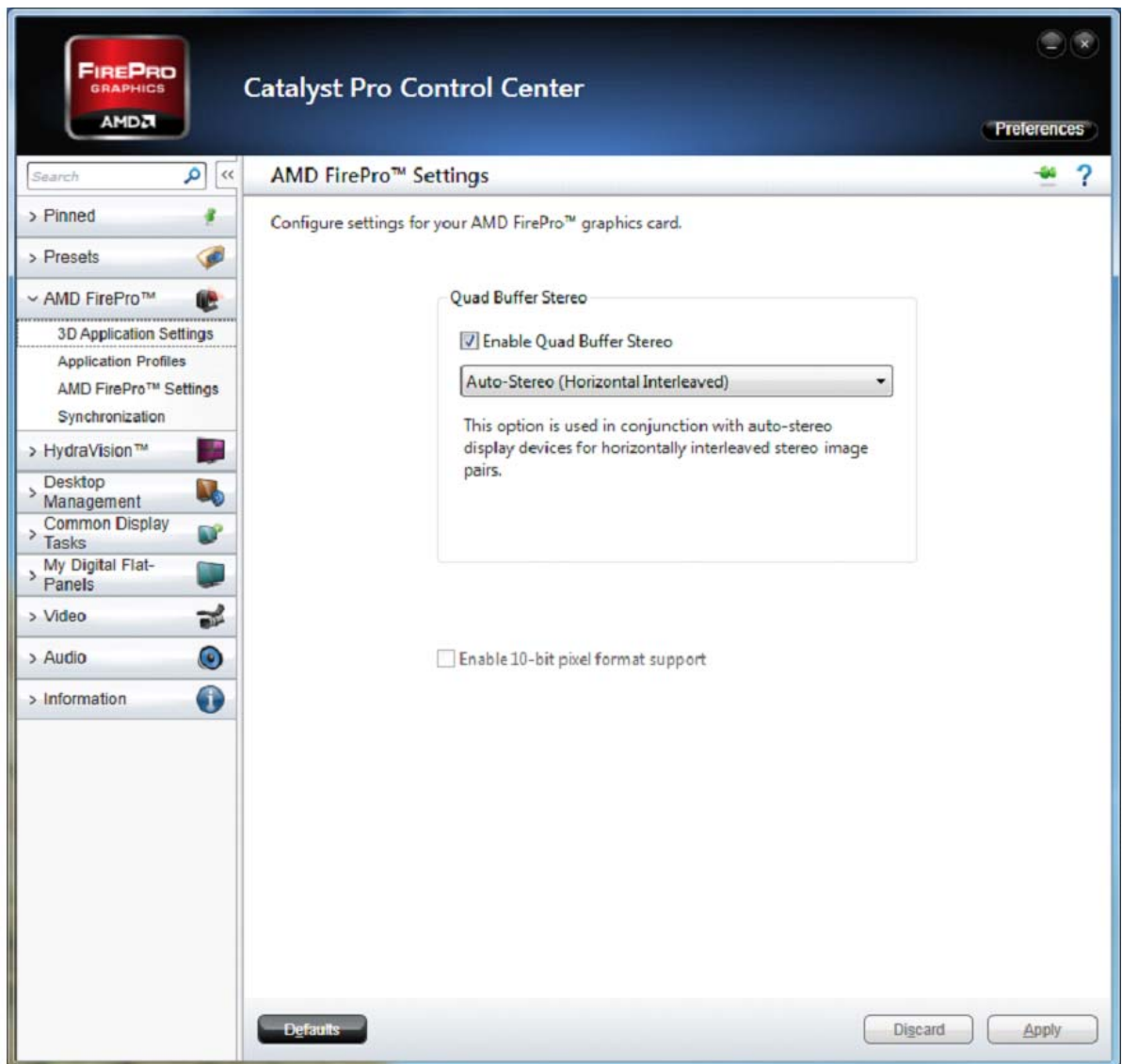

Note: A more detailed explanation of AMD card setup is given in "AMD Graphics Card Setup for Quadrant Outputs" on page 51.

- 1 Right click on the desktop and select **Catalyst Control Center**.
- 2 Select AMD FirePro, then select **3D Application Settings**.
- 3 Check the **Enable Quad Buffer Stereo** box.
- 4 Select **Auto-Stereo (Horizontal Interleaved)** from the selection box
- 5 Click **Apply**.
- 6 Open the 3D application and perform application-specific 3D setup.

Setting Up NVIDIA Graphics Cards for 3D Content

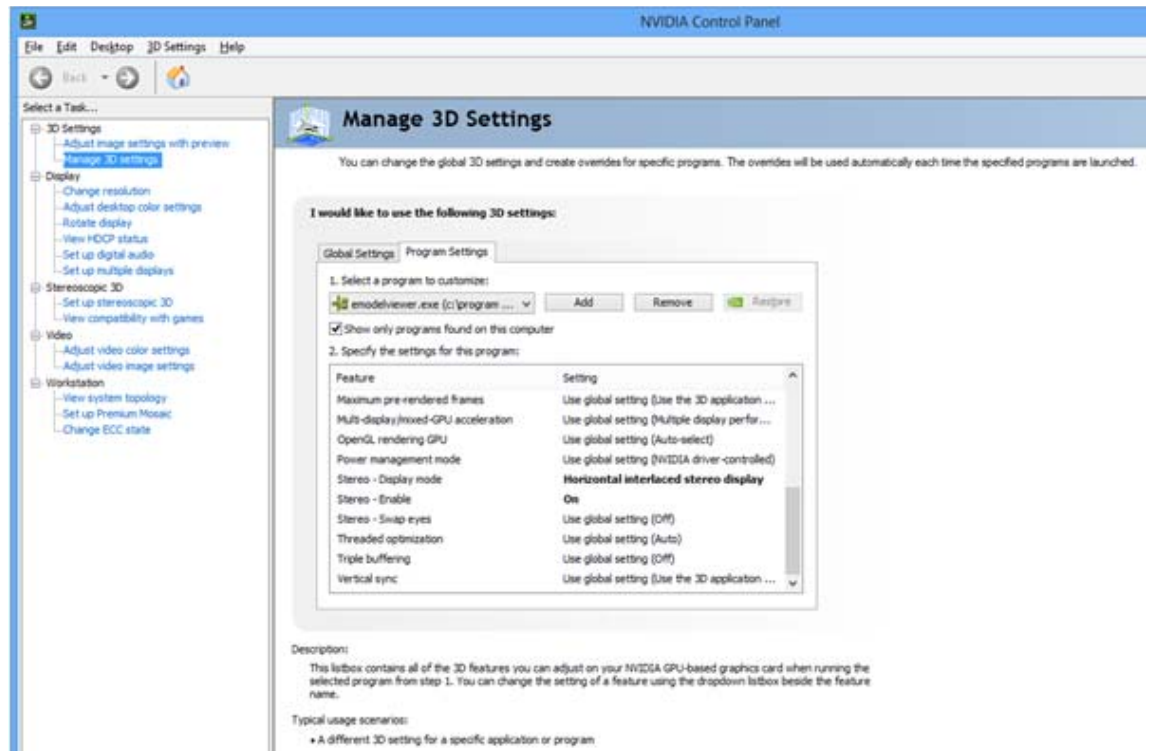

Note: A more detailed explanation of NVIDIA card setup is given in "NVIDIA Graphics Card Setup for Single Output" on page 53 or see "NVIDIA Graphics Card Setup for Quadrant Output" on page 59.

- 1 Right click on the desktop and select NVIDIA **Control Panel**.
- 2 Under 3D Settings, select **Manage 3D Settings**.
- 3 Select the **Program Settings** tab.
- 4 In section 1, select the program for which its 3D capabilities will be used. If the program is not listed, click **Add** and search for the program's **.exe** file.
- 5 In section 2, use the following settings:
 - a **Stereo – Display mode** = Horizontal interlaced stereo display
 - b **Stereo – Enable** = On
- 6 Repeat steps 4 and 5 for each 3D-enabled application that you wish to use.
- 7 Click **Apply**.
- 8 Open the 3D application and perform application-specific 3D setup.



Recommended PCs



In order to use 4K video, it is crucial that you have a high-powered PC. We also recommend using a single 4K output whenever possible. Doing so eliminates the requirement of multi-output synchronization.

Unpacking and Checking Accessories

LCD Module Box





The following items are included in the LCD module box.

Part	Description	Number	Picture
LCD module	One per box.	1	
LCD mounts (optional)	<p>If ordered, this will be inside a separate box inside the LCD box.</p> <p>Note: If you do not use Planar's mounts, you need to ensure the mounts that you purchase can adequately support the display.</p>	1	
Mounting template	Used to line up where the wall mounts will be installed. This is included with Planar's optional LCD mounts.	1	

Part	Description	Number	Picture
Kickstand bracket (84" only)	Mounts to the display when Planar mounts are purchased.	1	
M4 x 8 Panhead screws (84" only)	Used to mount the kickstand bracket.	4	
Lift block assembly (98" only)	Used as attachment points for lift assist machines.	2	
M8 x 35 Panhead screws (98" only)	Used to mount the lift blocks.	4	

Accessory Kit

The following items are included in the accessory kit.

Part	Description	Number Included	Picture
AC power cord	Power cord.	1	
IR sensor	Used to receive signals from the remote control.	1	
Double-sided tape	Used to help in mounting the IR sensor module.	2	
USB drive	Contains the User Manual and setup software.	1	
Passive USB cable	Used to set up display software.	1	
Remote control	Used to power the display on/off, select multiple or single inputs. Note: Batteries are included but not installed.	1	

Part	Description	Number Included	Picture
Carrying Strap	For lifting and carrying the display using two people	2	
3D glasses (98" only)	For viewing 3D content	4	

Installing the Displays

Before installation, keep the following points in mind:

- These displays are heavy. Make sure that you have adequate studs to support the weight of each display if installing on a wall.
- The UltraRes must be installed on a flat surface.
- If you ordered the optional wall mounts, use the supplied UltraRes mounting template for the center point of the display, as well as for top and bottom bracket installation.
- The wall mounts for a landscape and portrait installation look very similar. The process to install them is almost exactly the same. The only difference is the way in which you use the wall mount template. This will be pointed out in the relevant step.

Installing an UltraRes Display on a Wall

Caution: For whatever structure is used to mount the display, be sure that it is sufficiently engineered to handle the weight of the display. Also be sure to purchase the correct hardware needed to support the display mounted to that structure.

Caution: If the unit being installed is fitted with a touch input device, it is important that the touch frame is not used to lift the unit. Also, the unit should never be placed on the touch frame to support the unit.

- 1 Find the center point of the display on the wall where you intend to install it.

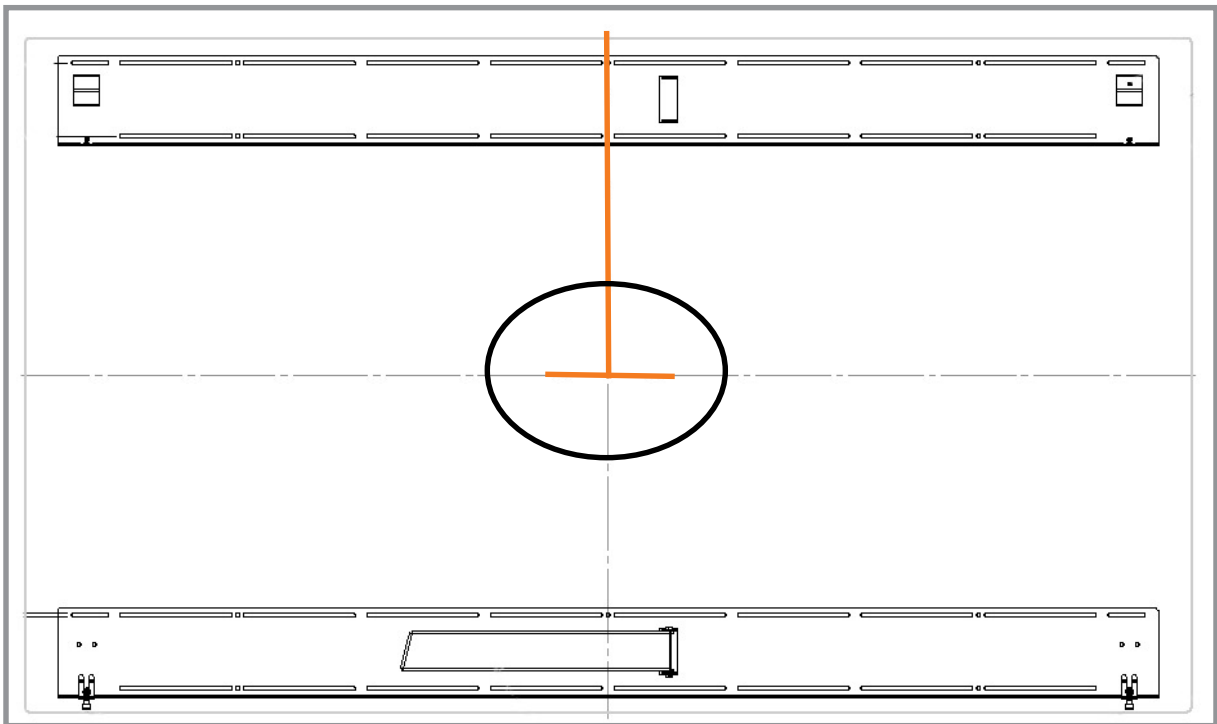

- 2 Draw a short (about 1") horizontal line and then a vertical line to just below the top edge of the display.

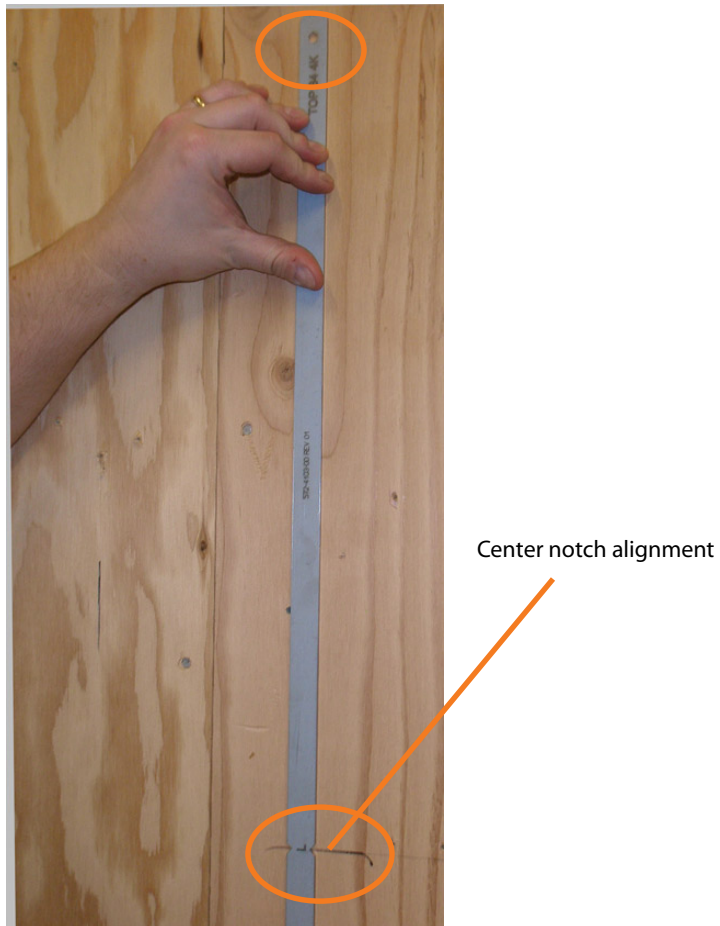

- 3 Use the provided template to determine the center points of the wall mounts. The "V" notches are labeled "L" for a landscape display or "P" for a portrait display. Use the appropriate "V" notch to align with the horizontal line drawn in the previous step.

- 4 In the hole marked "Top" on the template, mark the center of the hole on the wall. Be sure the vertical line runs through the center of the hole and that the template is plumb. You may wish to screw the template in place to make the next steps easier.

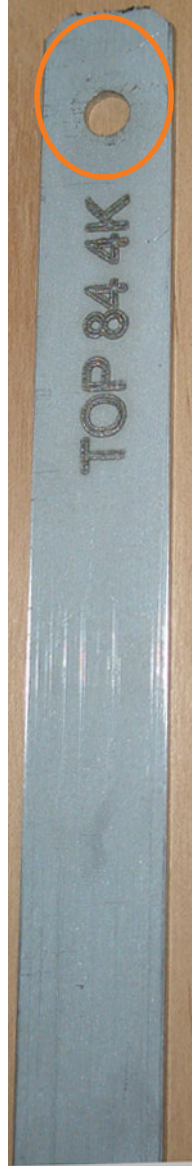

Note: If you are installing a landscape display and the template is too long, you can break the template at the notch labeled "P"

- 5 Let the template hang vertically so it is plumb, as the bottom hole in the template determines where the bottom mount will be installed.
- 6 Mark the center of the hole at the bottom of the template that corresponds with your display orientation.

- 7 If you have screwed the template in place, remove each screw and the template.
- 8 Line up the middle hole of the top wall mount with the screw hole drilled from the template.



Note: This picture shows mounts for a landscape installation.

- 9 Tighten the screw into the mount.
- 10 Use a level to make sure the mount is level.
- 11 Then install additional screws as needed.

Note: Screws installed near the mount hooks provide the best support.

- 12 Install the center screw in the bottom mount and repeat steps 10-11 for any additional screws that you want to install. Note that there are open mount channels on the brackets. So you can install the screws wherever necessary along those channels.

- 13** (84" only) Install the kickstand bracket to the back of the display using four M4 x 8 Panhead screws.



Landscape holes for kickstand bracket installation

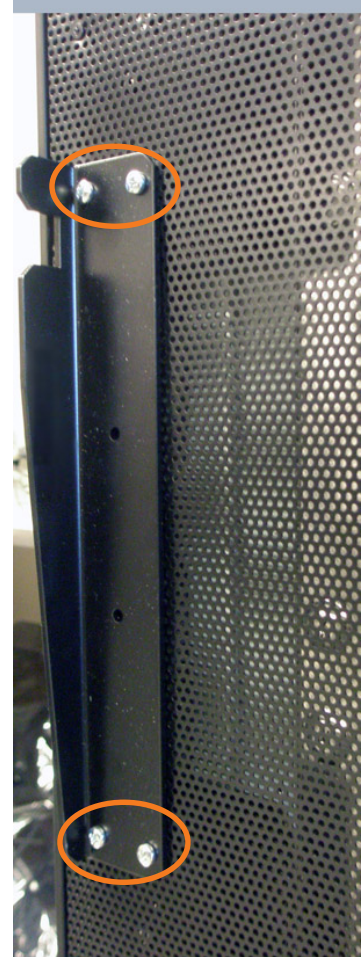

Portrait kickstand installed on display

- 14** Using three physically capable people, carefully hang the back of the display onto the top wall mount bracket using the square brackets on the back of the display.

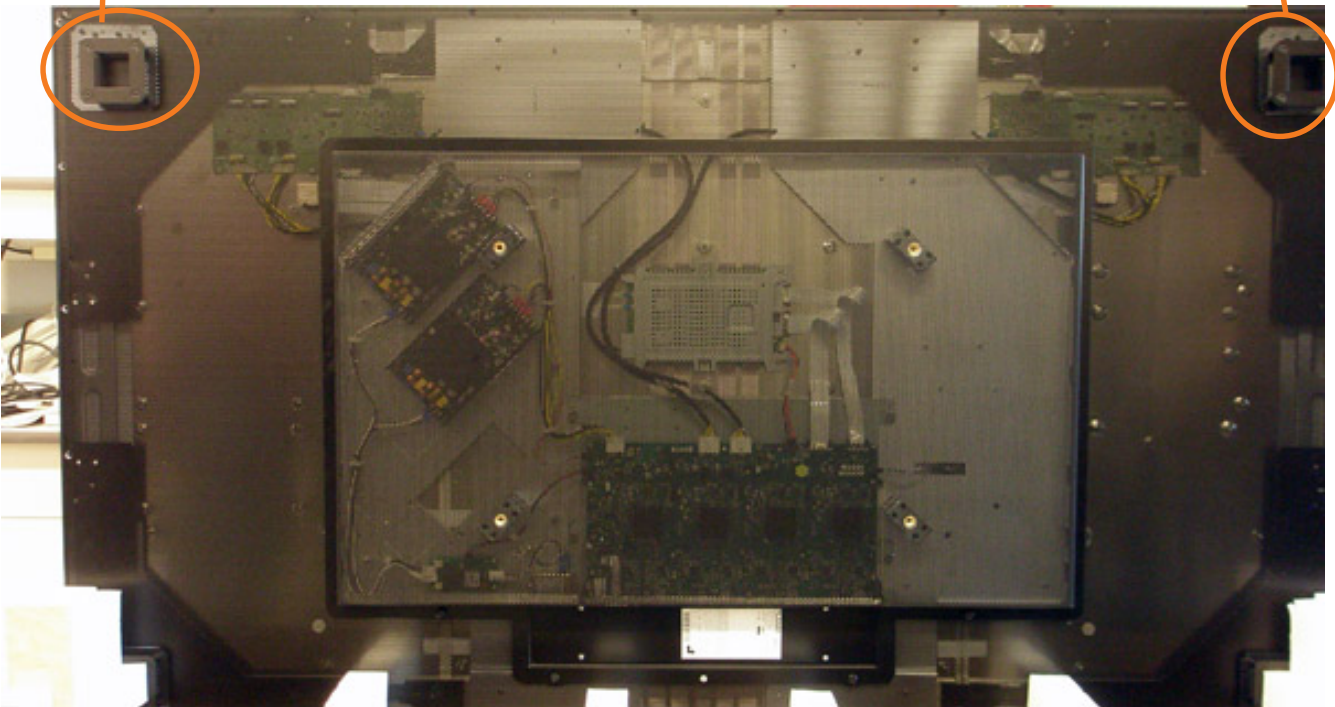

Caution: Be sure these are securely hung, as the top of the wall mount will hold all of the weight of the display.

As an alternative for the 98" model, you can use the lift blocks along with a lift assist mechanism to lift the panel into place. For details, refer to "Using the Lift Blocks (98" only)" on page 36.

- 15 On the bottom wall mount, there is locking hardware in the lower corners of the mount. Push the hardware up and finger tighten the captive screws on the bottom to secure the display to the wall.

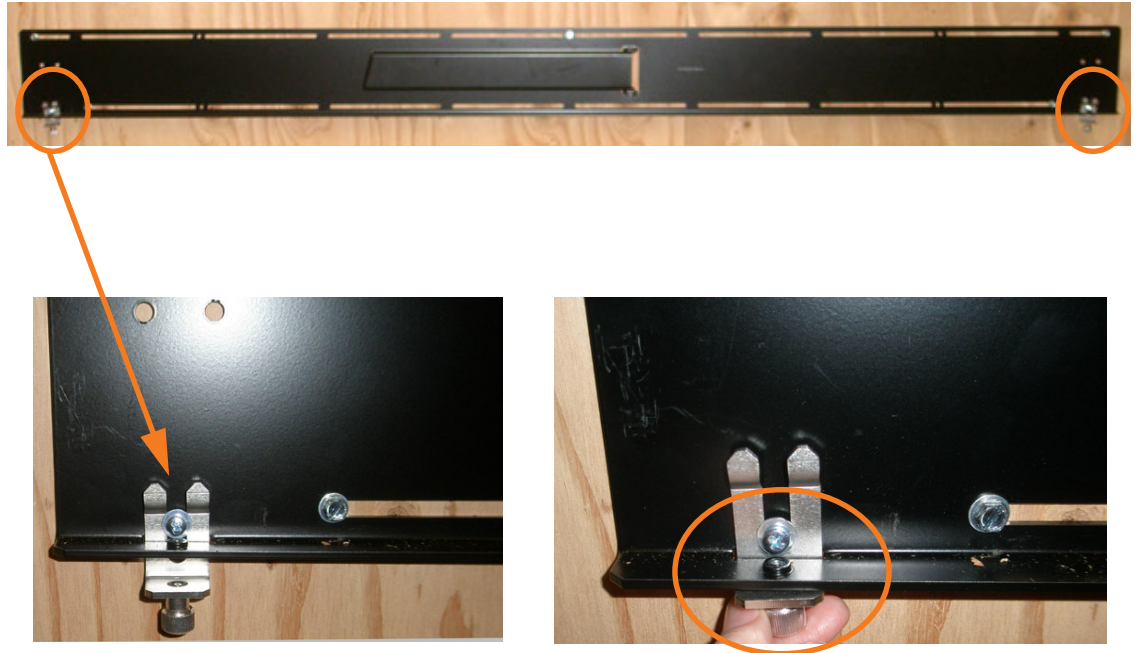

Using the Lift Blocks (98" only)

- 1 Attach the lift blocks to the back of the panel using the provided M8 x 35 pan head screws.
- 2 Securely attach your lift mechanism to the eyehooks:
 - a Spreader bar attachment: A spreader bar allows for a small lift profile and less stress on the panel and eyehooks than a single point attachment. This is the preferred method.

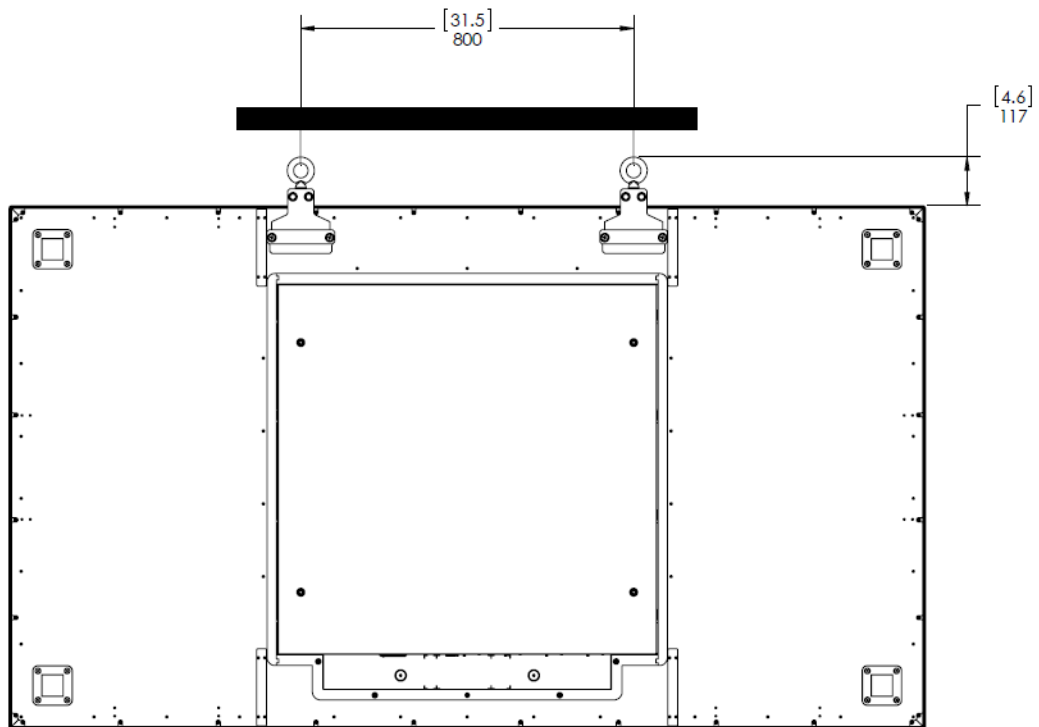

- b Single point attachment: The angle between the top of the panel and the support lines should not be less than 45 degrees. This means that the attachment point must be at least 485 mm (19.1 in) above the top of the panel.

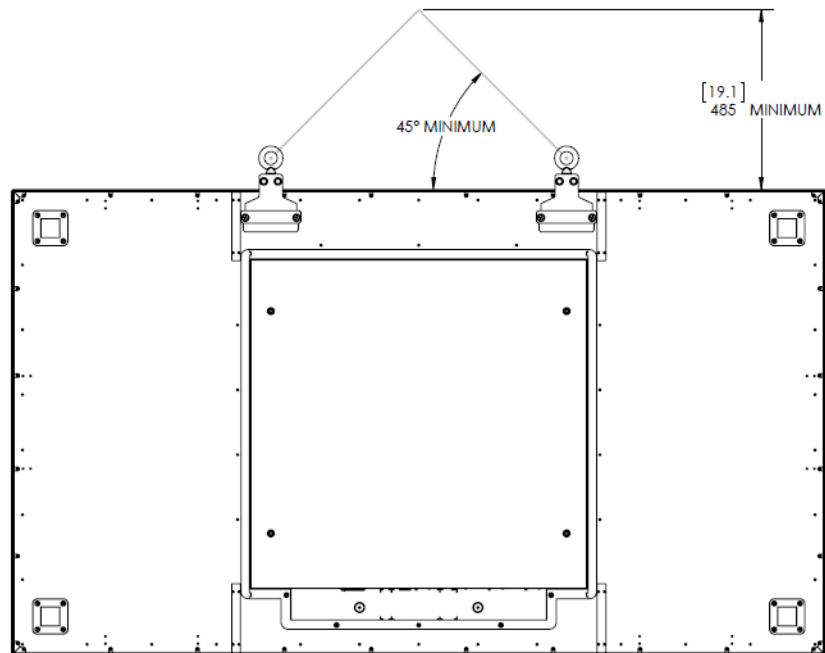

- 3 Lift the panel into place.
- 4 Detach the upper half of the lift block from the lower half by removing the two vertical screws. This leaves the bottom half attached to the panel but hidden.

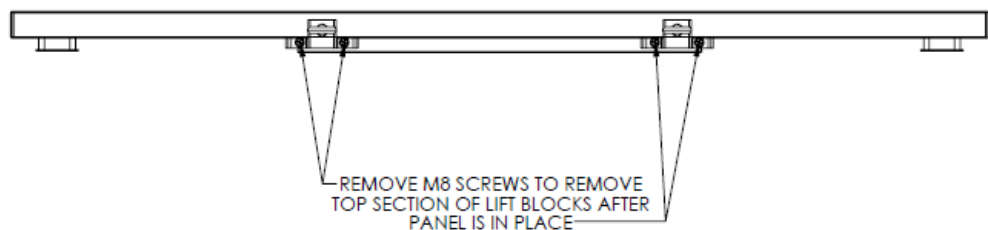

Using the Kickstand Bracket

The kickstand bracket is used for service mode, without having to remove the display from the wall. Use the following instructions to put the display in service mode.

- 1 Loosen the captive locking screws on both sides of the bottom mount, and let the brackets hang down freely.



- 2 Pull the display out and then swing out the kickstand(s) to hold it in place. The kickstand(s) will nest into the kickstand bracket notch(es). For 98" panels, make sure to use both kickstands as using only one can cause stresses in the panel that could cause damage.

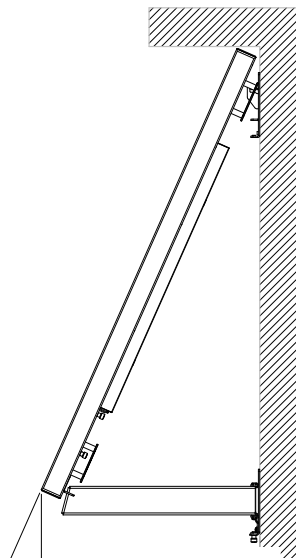

Service position -
with kickstand
supporting display

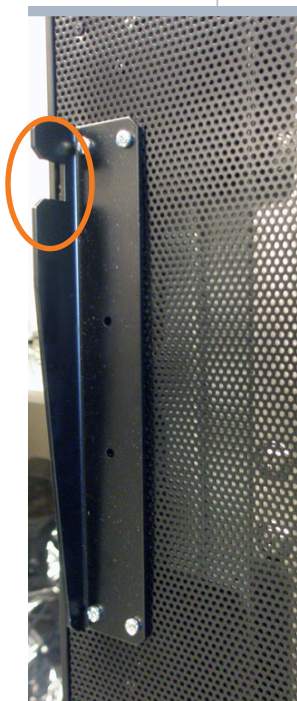

Connections

To get the UltraRes display up and running, you need to make three main connections: AC power, the wired IR module and your sources.

Connecting AC Power

Using the supplied AC power cord, connect one end to a grounded outlet and the other to the AC power input next to the I/O panel the bottom of the UltraRes display.



Connecting the Wired IR Module

In order for the remote control to work, you need to connect the wired IR module to the display, also on the bottom of the I/O panel. Then place the IR receiver in the desired place on or near the display.



IR receiver



Connecting Sources

There are three modes of operation

- 1 Single Input**
 - 4K @ 24/25/30Hz
 - 4K @ 50/60Hz (HDMI 4:2:0)
 - 1080p @ 24/25/30/50/60Hz
 - 1080i @ 50/60Hz
 - 720p @ 50/60Hz
- 2 Four-headed input**
 - 4K @ 24/25/30Hz
 - 4K @ 50/60Hz (HDMI 4:2:0)
 - 1080p @ 24/25/30/50/60Hz
 - 1080i @ 50/60Hz
 - 720p @ 50/60Hz
- 3 Two-headed input**
 - 960x2160 @ 60Hz
 - 1920x2160 @ 60Hz, using inputs 1 & 3 or 2 & 4

Setting up for Single Input Sources

Connect from a single-headed source to the display. If the image is 4K, it will fill the whole screen. For non-4K signals, the image is upscaled to 4K.

- PC with 4K @ 24/25/30Hz output
- 4K Blu-ray player such as a Sony BDP-S790



Select the input source using either the remote control or UltraRes Control Software from the computer.

Selecting a single source with the remote

Press the button that has
the 4K source connected

Select **Single**



Selecting a single source with UltraRes Control Software

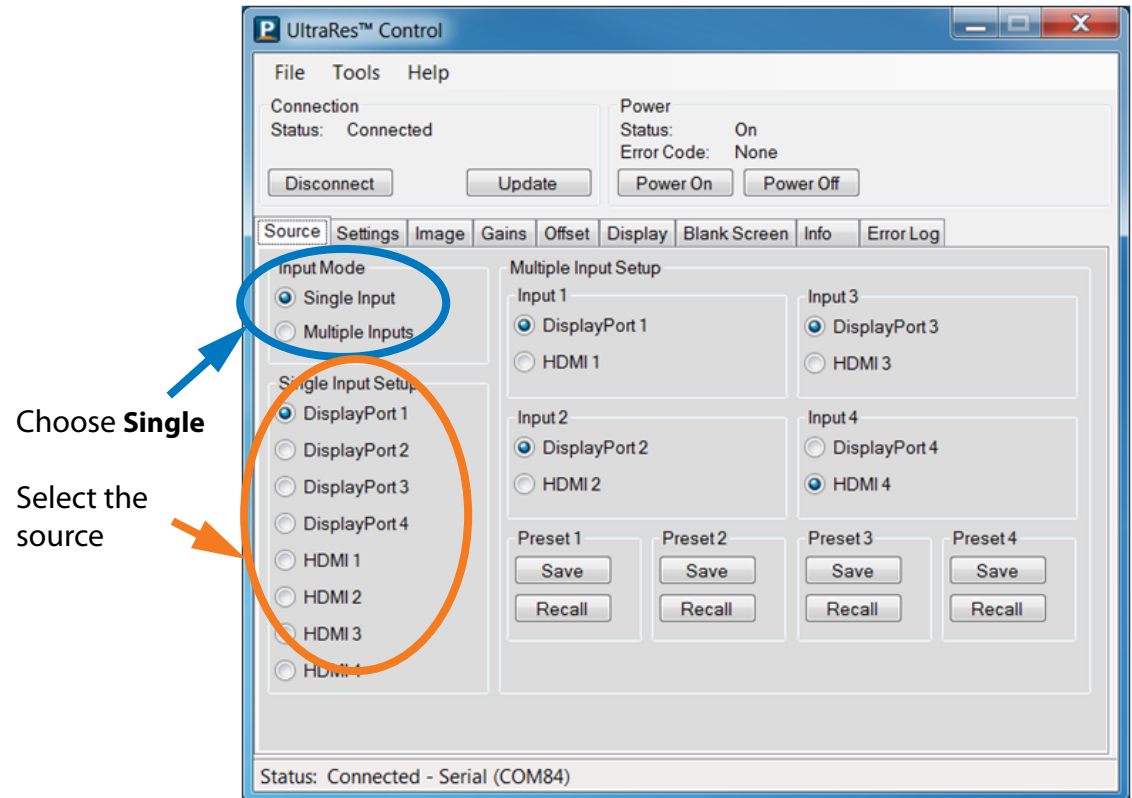

Note: For a more complete description of the Control Software, how to install it and how to use it, see "Installing the UltraRes Control Software" on page 61 and "Using the UltraRes Control Software" on page 65.

Setting up for Multiple Input Sources

Multiple input sources can be managed efficiently with UltraRes MediaPlex. Multiple inputs can be

- four signals of any resolution or frame rate
- 4K sources downscaled into quadrants
- below 1080p upscaled into quadrants
- two 1920 x 2160 sources displayed as two halves instead of quadrants

Selecting multiple sources with the remote

Select **Multiple**

Press the buttons for each source that you want to display. For example, to display HDMI 1, DisplayPort 2, HDMI 3, and DisplayPort 4, press the HDMI 1, DP 2, HDMI 3, and DP 4 buttons.

Selecting multiple sources with UltraRes Control Software

When you use the UltraRes Control software to set up multiple sources, there are three different settings *per input channel*. Make sure you have selected the **Multiple Inputs** radio button in the lower left corner.

Choose
**Multiple
Inputs**

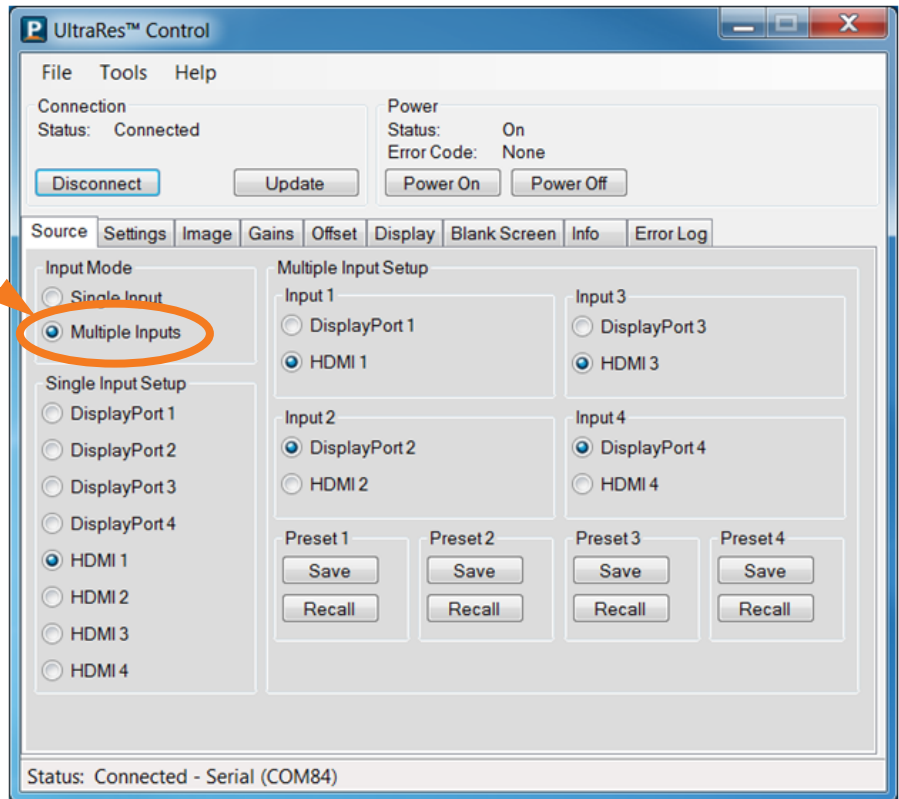

There are three basic types of 4K sources:

- PCs with NVIDIA graphics cards, such as NVIDIA Quadro K5000
- PCs with AMD graphics cards, such as AMD Radeon 7970
- HDMI 4K sources like Blu-ray, such as Sony BDP-S790

Note: Apple has provided support for 4K output only on MacBook Pro and Mac Pro units manufactured after late 2013. Apple has not yet provided support for 4K output from units manufactured prior to that date or other Mac units. However, a 4K output does work when the Mac is running Windows in Boot Camp.

- 1 Connect to the display with UltraRes Control.

- 2 In the **Multiple Input Setup** area, select the input that will be used for **Input 1**.

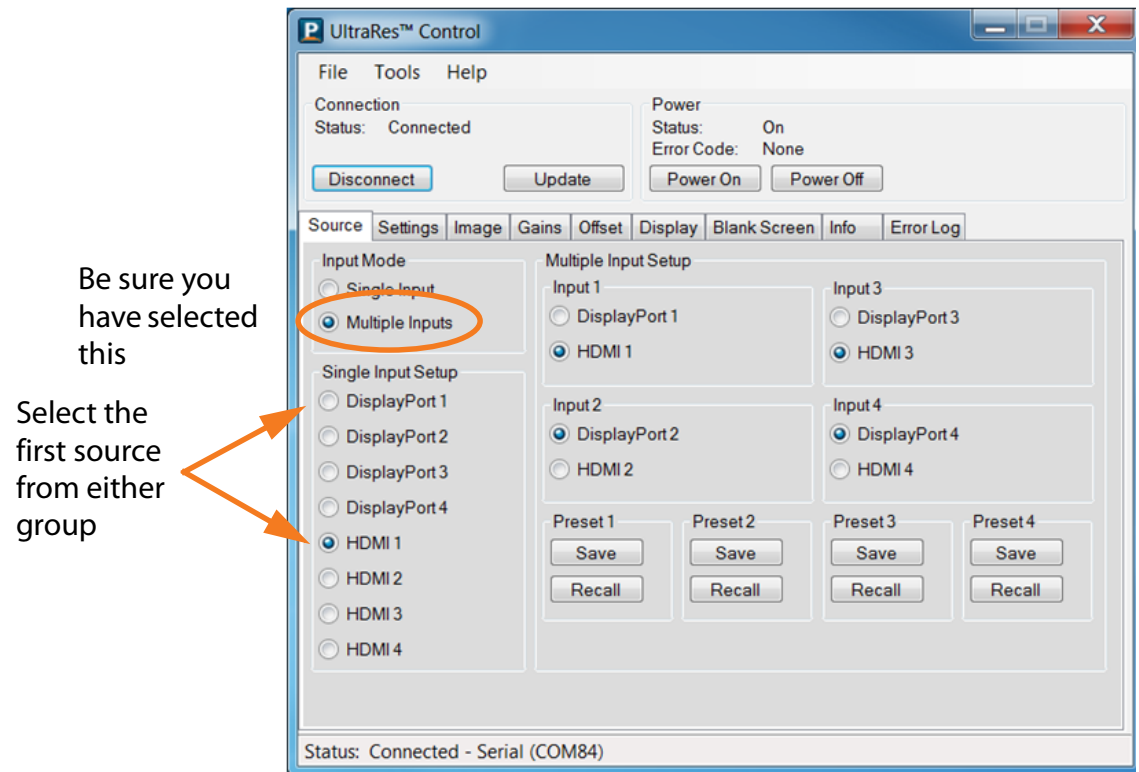

Note: You can't use both input connectors *at the same time* on one input.



Not both at the same time

- 3 Do the same for each of the other input sources.

- 4 When you have finished, click **Update**.

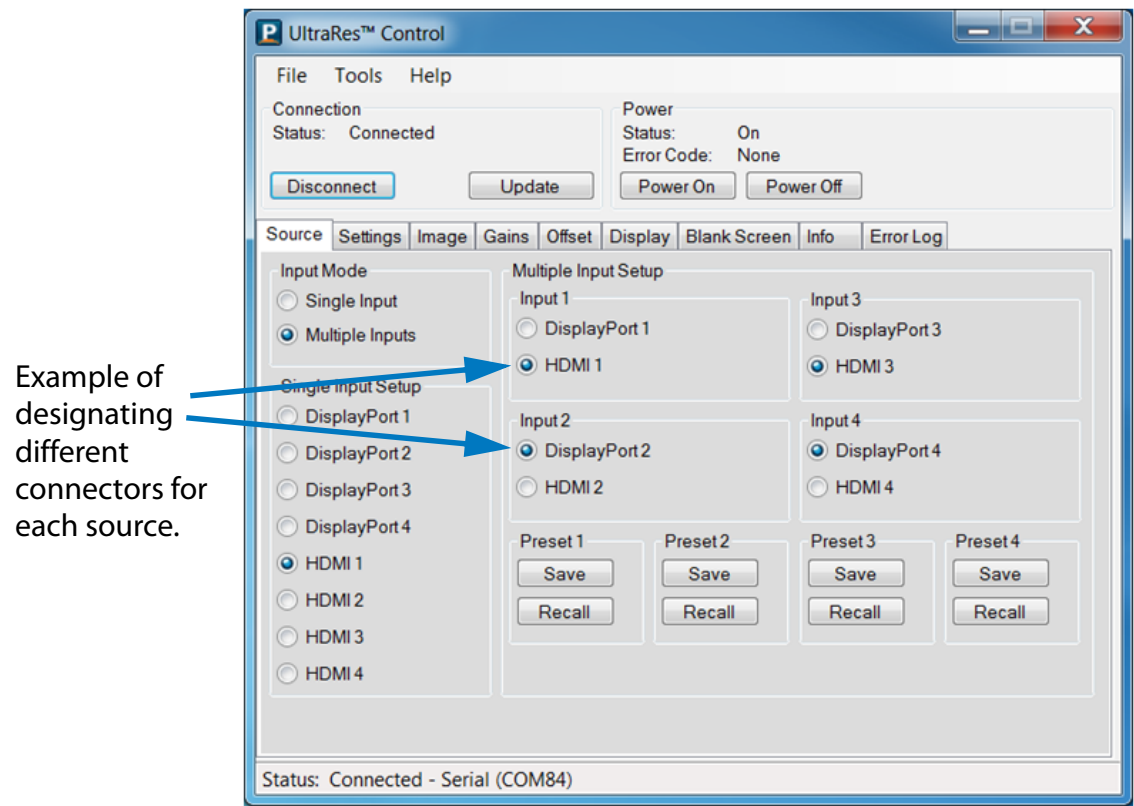

Setting up for 4K Support

Setting up the EDID information

The Planar UltraRes defaults to an EDID that indicates it is 1080p/60Hz display. Many graphics cards can't handle 4K timing, so you must setup the EDIDs to indicate 4K timing. You must do this for *each* of the sources.

- 1 Connect with UltraRes Control
- 2 Select the input source

- 3 Set the EDID Type to **4K 60Hz Preferred (HDMI)** if using 4K @ 50/60Hz 4:2:0. Otherwise, set the EDID type to **4K 30Hz Preferred**.

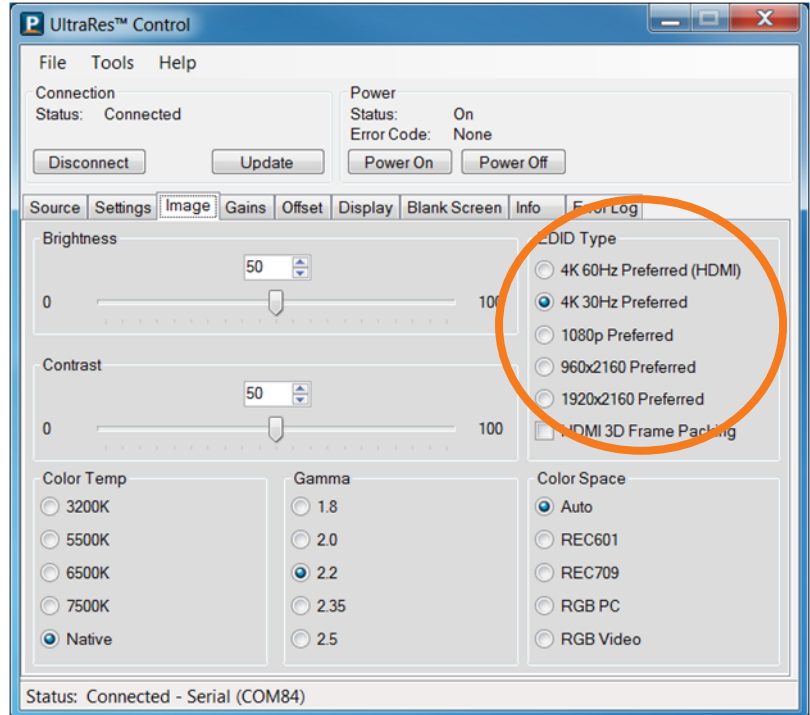

Screen Resolution Setup

If your source is 4K @ 24Hz, you will use that one. (This is the best one for film content.) For all others, use 4K @ 30Hz.

- 1 On the Desktop of your computer, right click and choose "Screen Resolution."
- 2 In the dropdown list of displays, find and click "Planar UltraRes."
- 3 Under "Multiple Displays," choose "Extend desktop to this display."
- 4 Click "Apply."

5 After this is done, click **Keep Changes**.

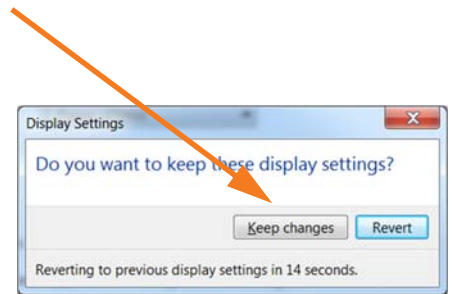
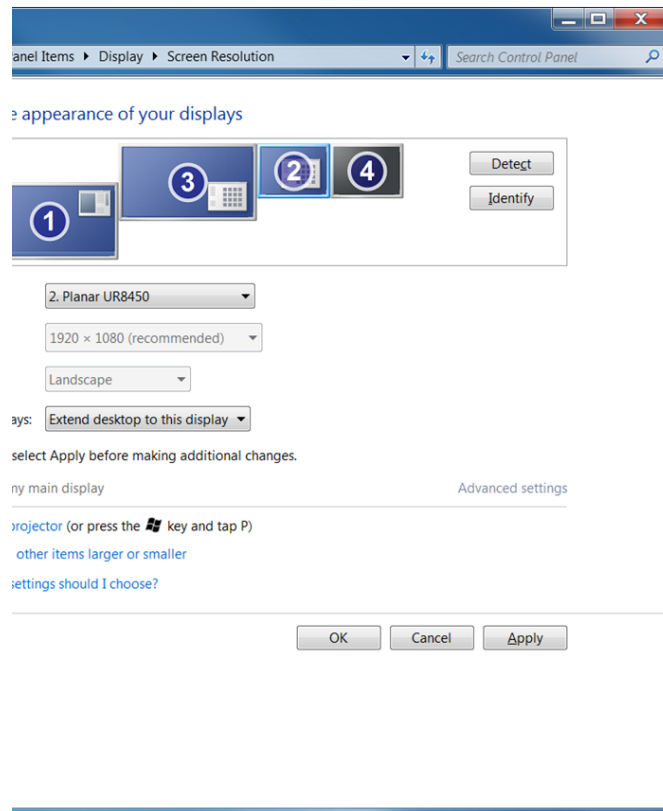

- 6 Use the Resolution selection box to see if 3840x2160 is already listed
 - If it is **currently selected**, you are finished.
 - If it is **in the list but not selected**, select it and click Apply.
 - If it is **not in the list**, then you have to set it up as a custom resolution. This is often required for NVIDIA graphics cards, though newer drivers have fixed this problem.

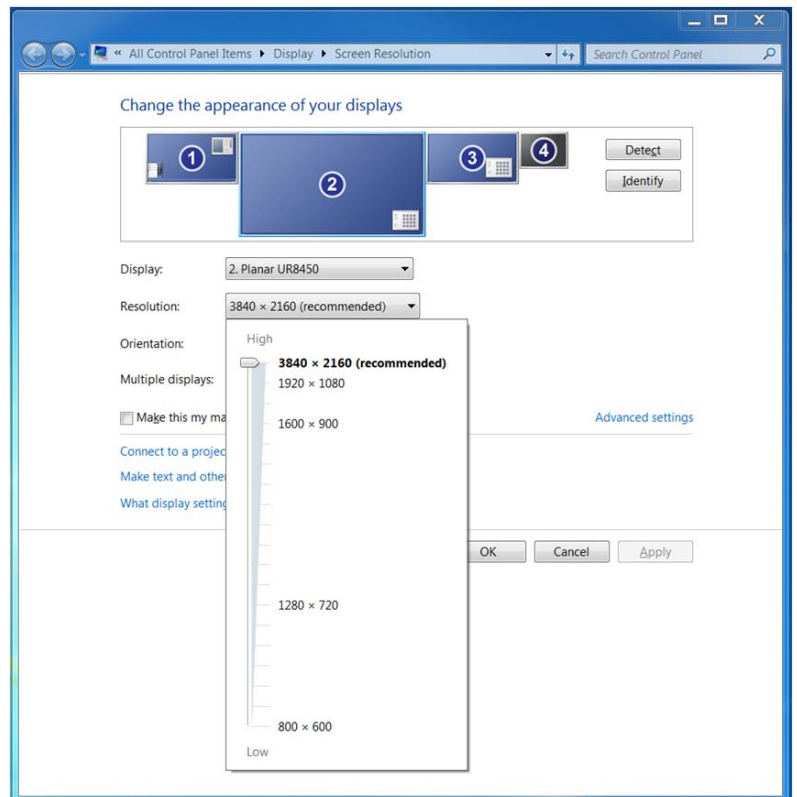

Graphics Card Setup

To display pictures with 4K resolution (4 x 1080p or 2x 1920x2160) the PC graphic card must be configured properly. This chapter tells how to setup up the graphics card for single or quadrant outputs for both NVIDIA and AMD graphics cards.

For single outputs (24Hz or 30Hz), the graphics cards must be set up for correct timing output.

For quadrant outputs (4x 1080p or 2x 1920x2160), the quadrants must be seamed together to create one large image.

For card type...	... using single output	... using quadrant output
AMD	configuration is automatic	see "AMD Graphics Card Setup for Quadrant Outputs" on page 51
NVIDIA	see "NVIDIA Graphics Card Setup for Single Output" on page 53	see "NVIDIA Graphics Card Setup for Quadrant Output" on page 59

AMD Graphics Card Setup for Quadrant Outputs

- 1 Right click on the desktop and select **Catalyst Control Center**.

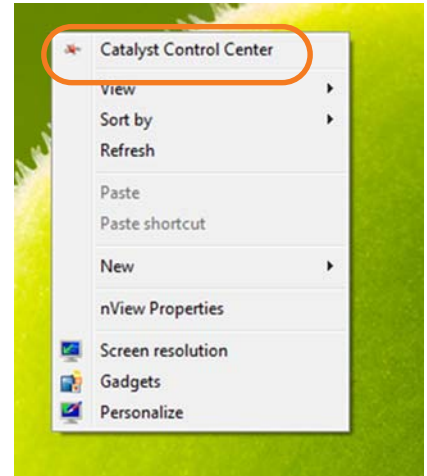

- 2 Select **AMD Eyefinity Multi-Display**, then select **Create Eyefinity Display Group**.

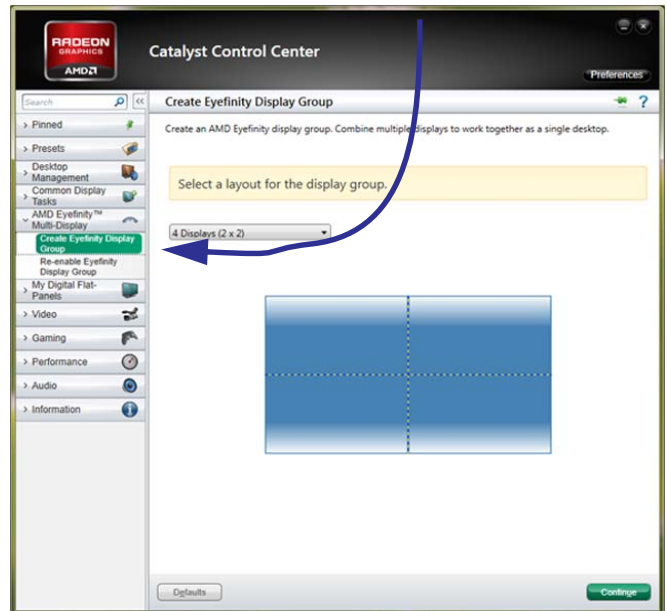

- Each quadrant will be shown separately in blue. Select each quadrant in the CCC window to indicate its location. CCC will arrange the quadrants to show one unified display.

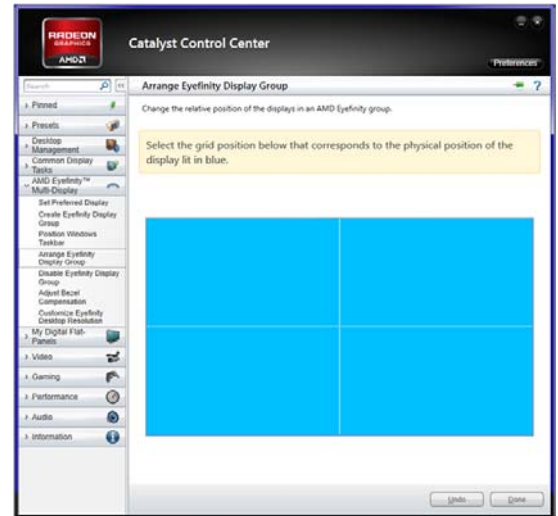

- Click **Done**. AMD graphics card setup is complete.



NVIDIA Graphics Card Setup for Single Output

Note: Older versions of the NVIDIA drivers do not support 4K. To see the version of your current card, right click on the desktop and select NVIDIA CONTROL PANEL.

Now go to **Help** → **System Information**. Check the **Driver version** field. It should be 311.15 or later. We recommend using the latest version, 340.66 as of 12 September 2014, because newer versions make 4K output easier to set up.

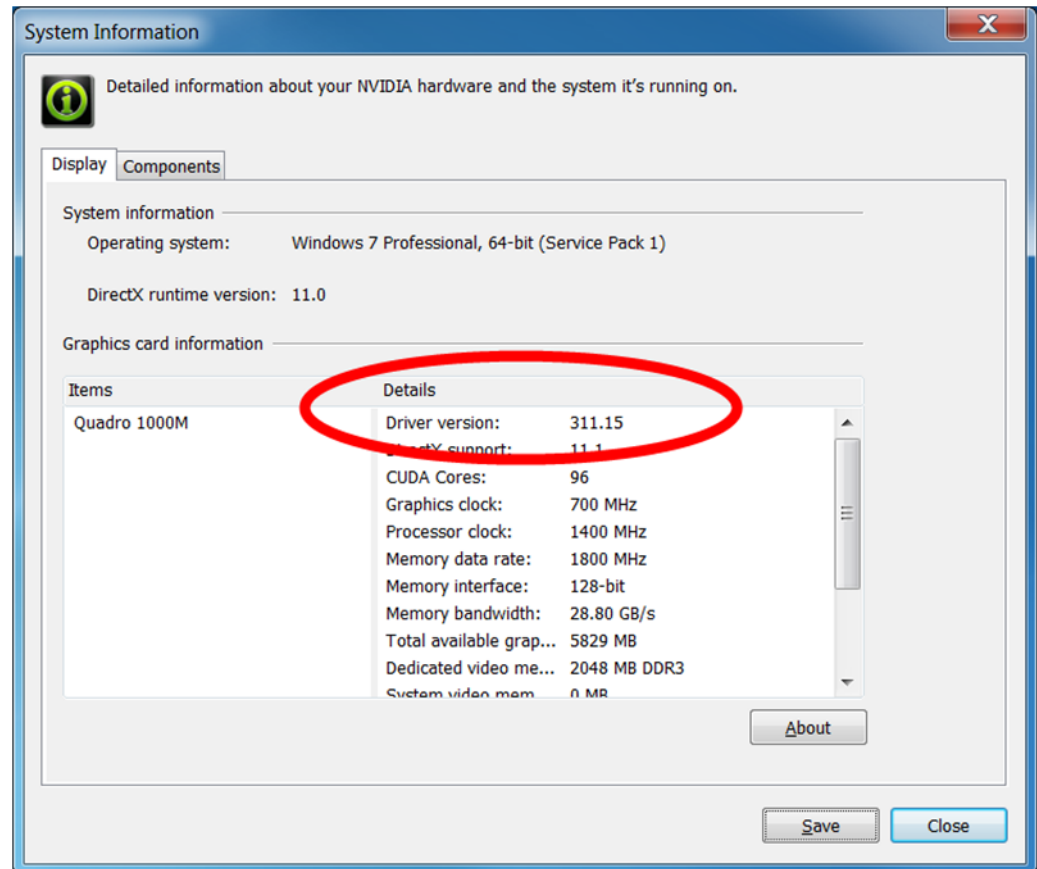

If you do *not* have a version beyond 311, do these steps:

- 1 On the desktop, right click and select NVIDIA Control Panel.

2 Select **Change Resolution** on the left.

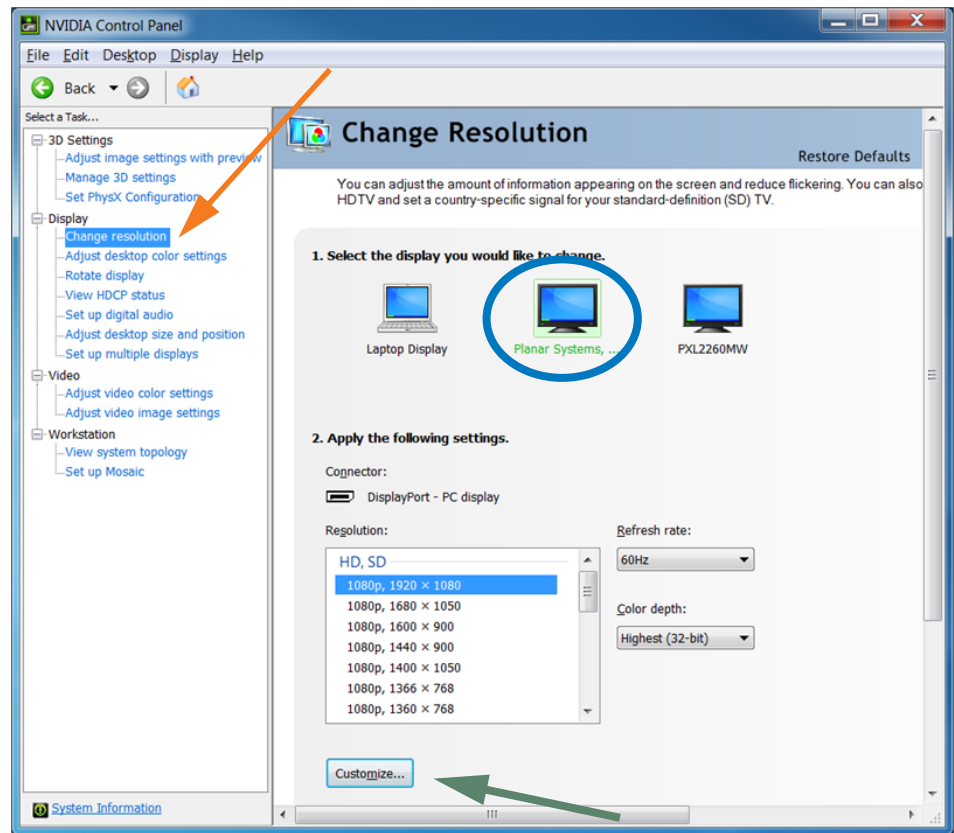

3 Select **Planar Systems Inc. Planar UltraRes** in the list of displays.

Note: If using 4K @ 60Hz 4:2:0, under Resolution, select **3840 x 2160** in the PC list and click **Apply**. Note that the Refresh rate box shows 60Hz. You can then skip steps 4-9.

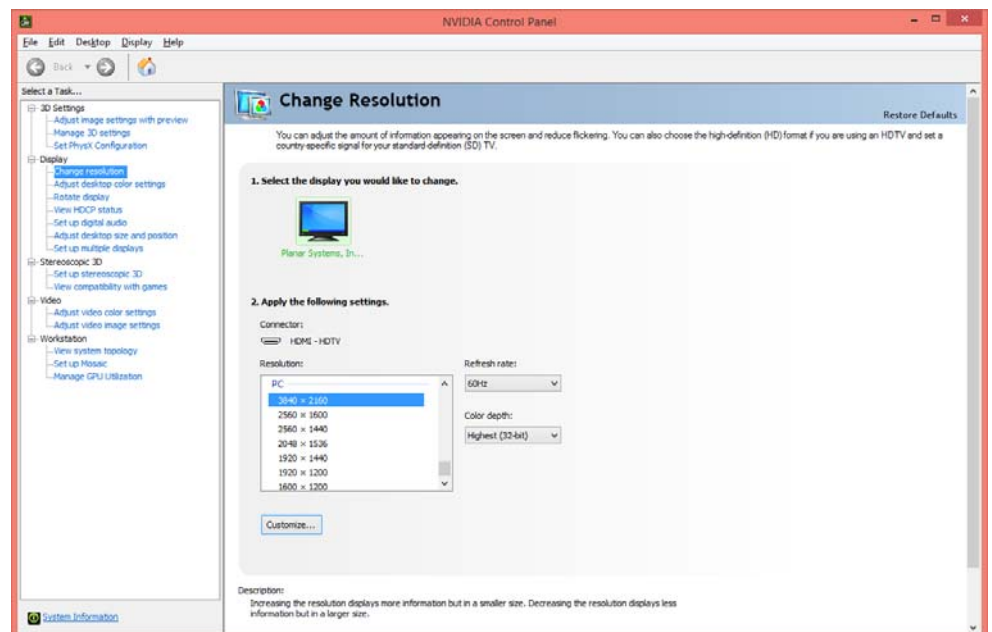

- 4 Click the **Customize** button at the bottom.

Check **Enable resolutions not exposed by the display**.

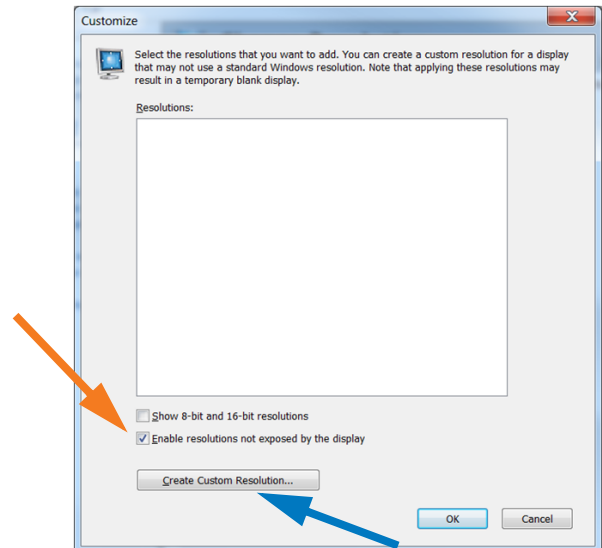

- 5 Click **Create Custom Resolution**.
- 6 Set the parameters as shown in the table:

Note: If your NVIDIA card is newer, beyond 311, you can skip this manual setup. Instead, in the Standard: dropdown list, choose **CVT Reduced Blanking** or **Automatic**.

Parameter	4K @ 24Hz output timing	4K @ 30Hz output timing
Horiz pixels	3840	
Vertical lines	2160	
Refresh rate	24Hz	30Hz
Scan type	Progressive	
Standard	Manual	
Active pixels	H= 3840, V= 2160	
Front porch	H= 1276, V= 8	H= 176, V= 8
Sync width	H= 88, V= 10	
Total pixels	H= 5500, V= 2250	H= 4400, V= 2250
Polarity	H= +, V= +	

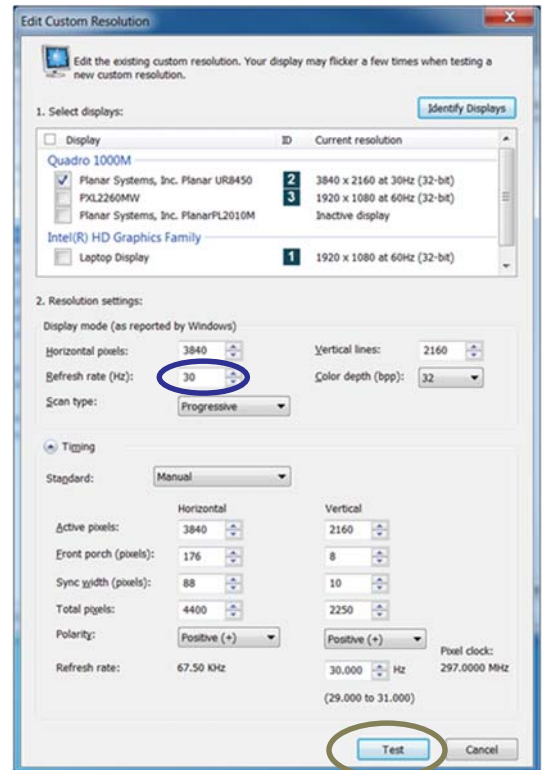
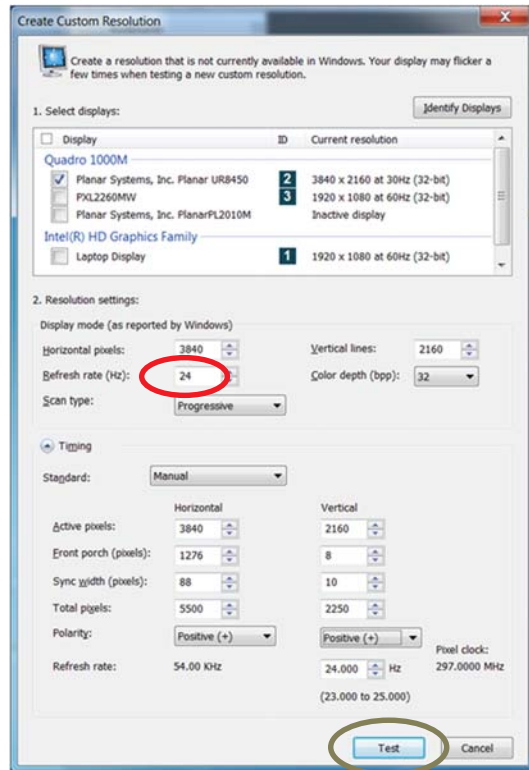

Note: For 1920 x 2160 @ 60 Hz, the setup is similar but with the following differences:

- Horizontal pixels: 1920
- Vertical lines: 2160
- Refresh rate: 60 Hz
- Standard: CVT Reduced Blanking or Automatic

7 Click the **Test** button.

8 Click **Yes** to save your new timing. The new timing will show in the Customize list. Click **OK**.

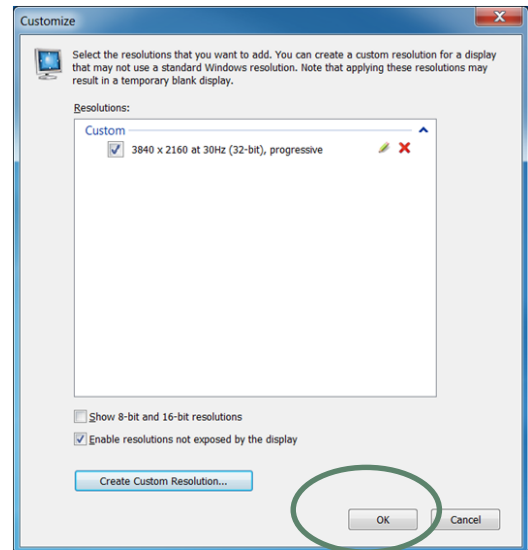
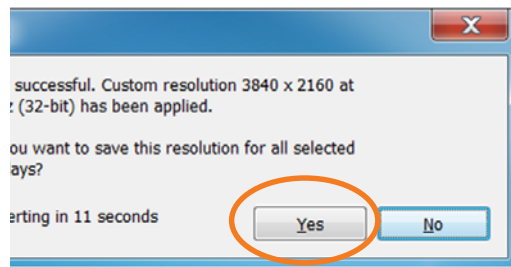

9 Click **Yes** to confirm the change.

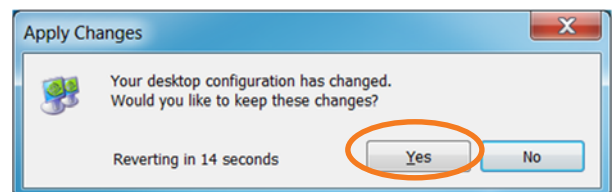
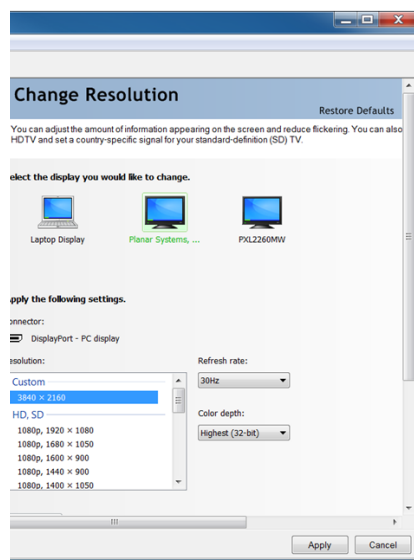

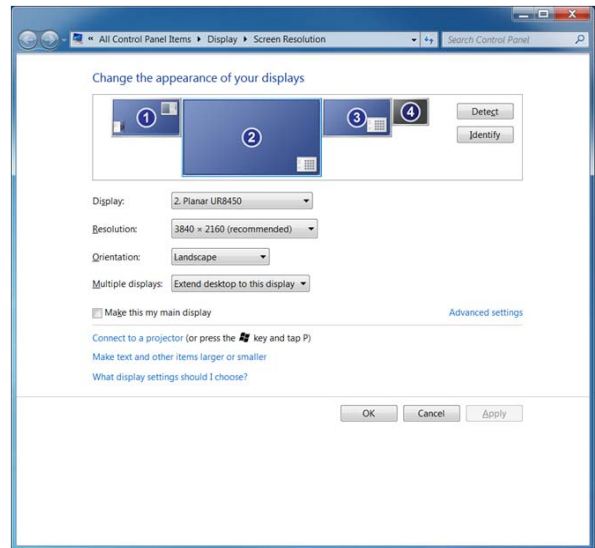
10 Close the NVIDIA Control Panel window.

NVIDIA Graphics Card Setup for Quadrant Output

- 1 Right click on the desktop and select **NVIDIA Control Panel**.

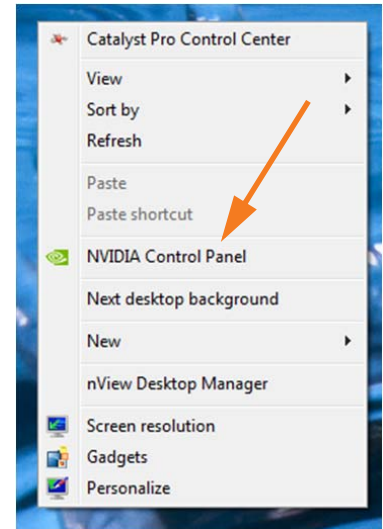

- 2 Select **Set up Premium Mosaic** and check **Enable Premium Mosaic**.

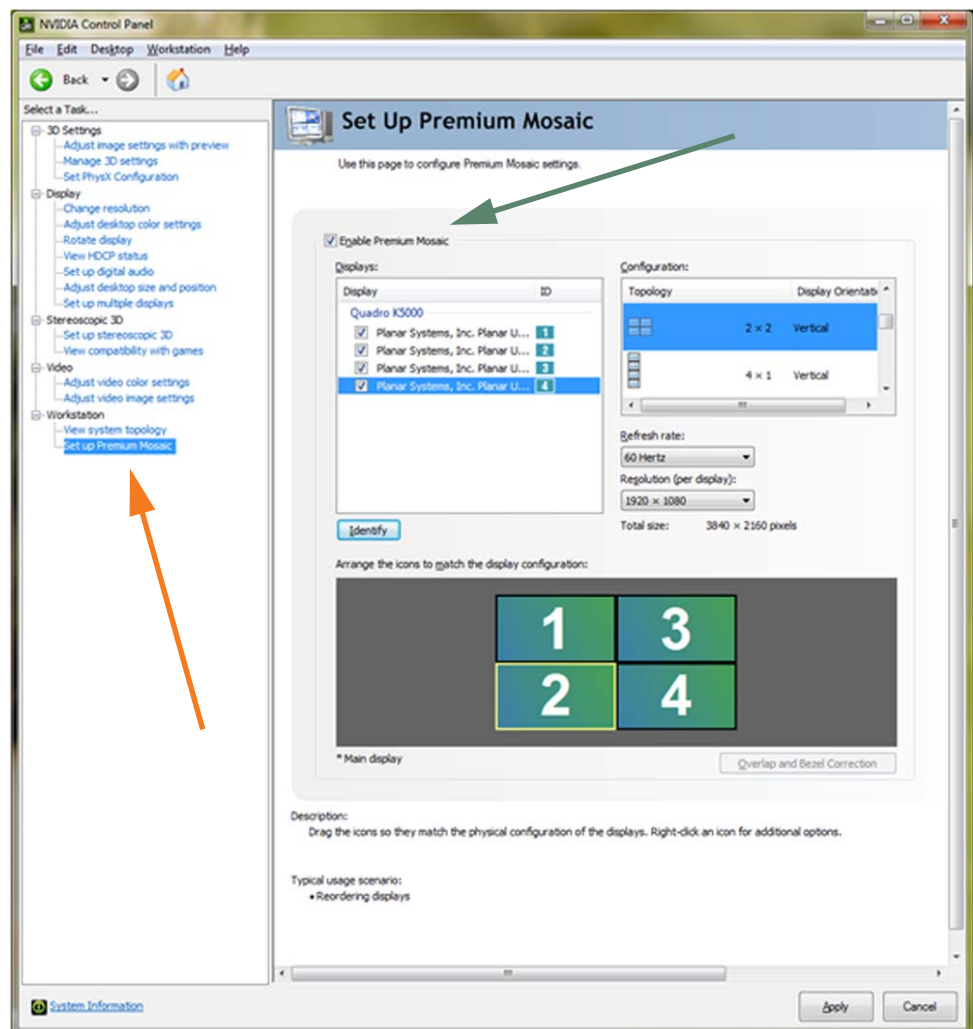

- 3 Check the box for all four of the **displays** shown.

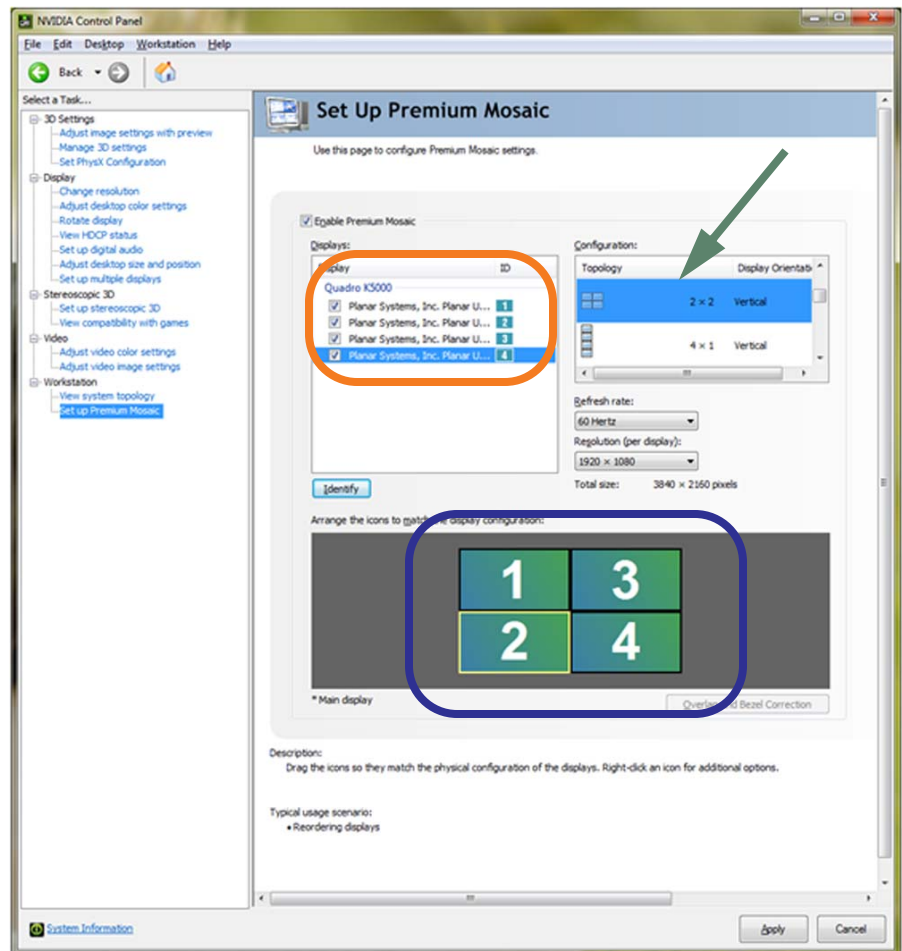

- 4 Under **Configuration**, select **2x2**.
- 5 Arrange the **display numbers** to match the diagram shown above.
- 6 Click **Apply**.

Installing the UltraRes Control Software

The UltraRes Control software is used as your primary tool for display setup. Use the following instructions to install the UltraRes Control software.

- 1 Save the **UltraRes Control.msi** program to your computer's hard drive.
- 2 Double click the **msi** file to open the installer program.

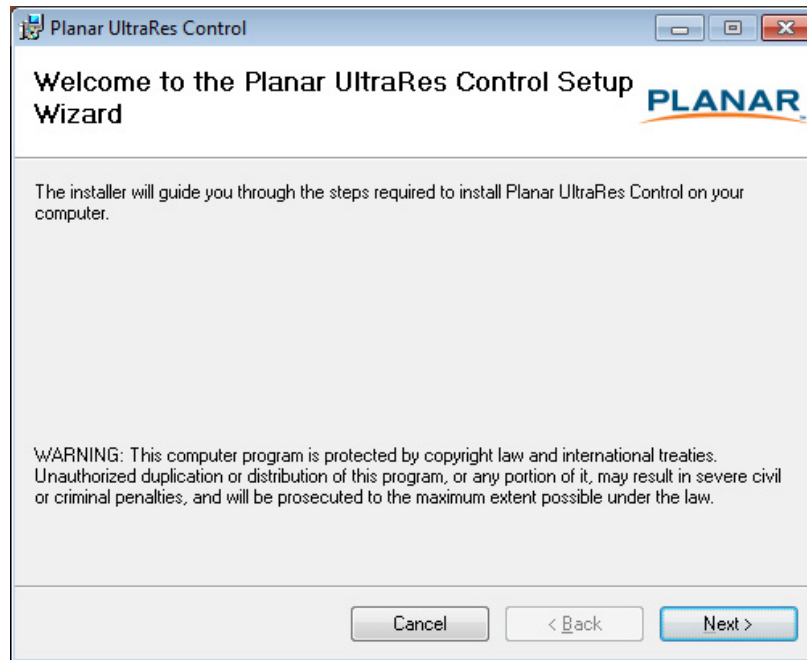

- 3 Click **Next** to continue.

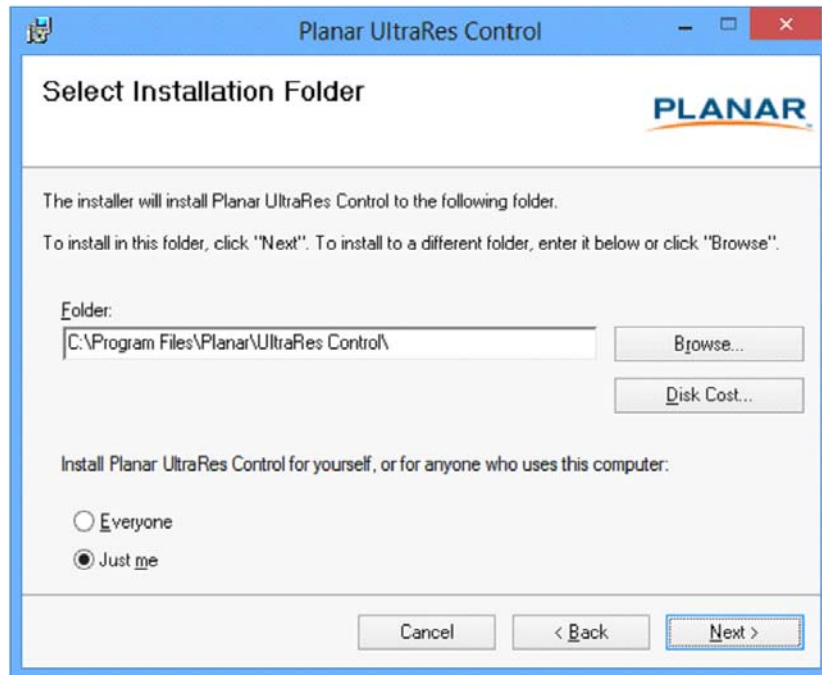

- 4 If you want to save the UltraRes Control files to a different location, click the **Browse** button and save to the folder of your choice.
- 5 If you want to see how much space is on your hard drive, click the **Disk Cost...** button to review storage capacity.
- 6 Do one of the following:
 - If you want other users to have access to the UltraRes Control software, select the **Everyone** radio button.
 - If you want to be the only user who can access the UltraRes Control software, select the **Just me** radio button.
- 7 Click **Next** to continue.

- 8 Click **Next** to continue.

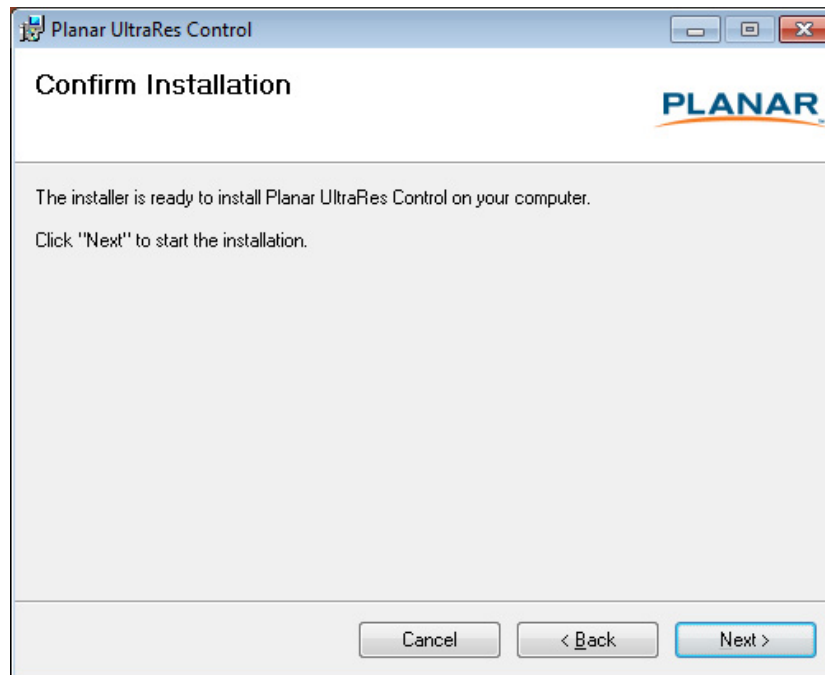

- 9 As the installation is occurring, you will see the status bar for up to a couple of minutes.

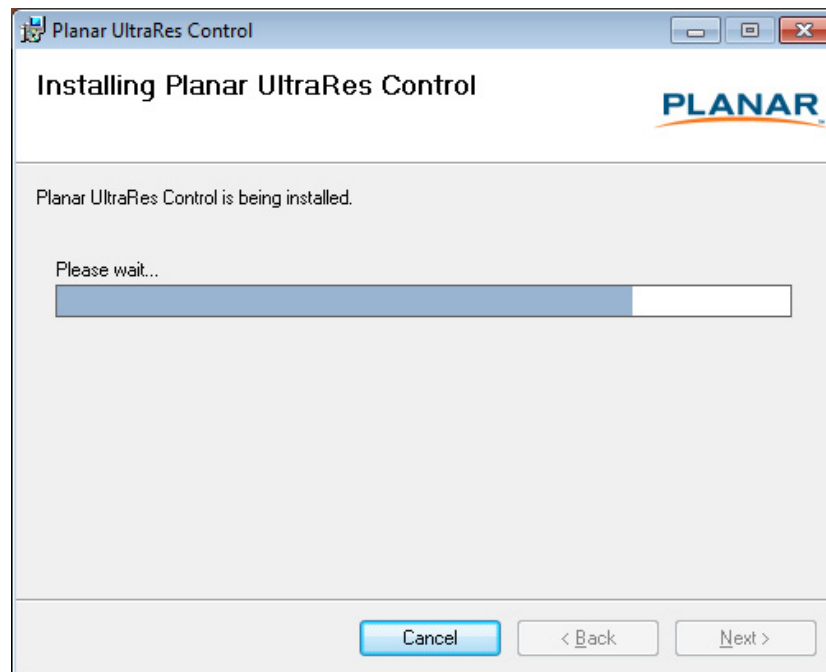

- 10 Once the installation is complete, click **Close** to close the program.

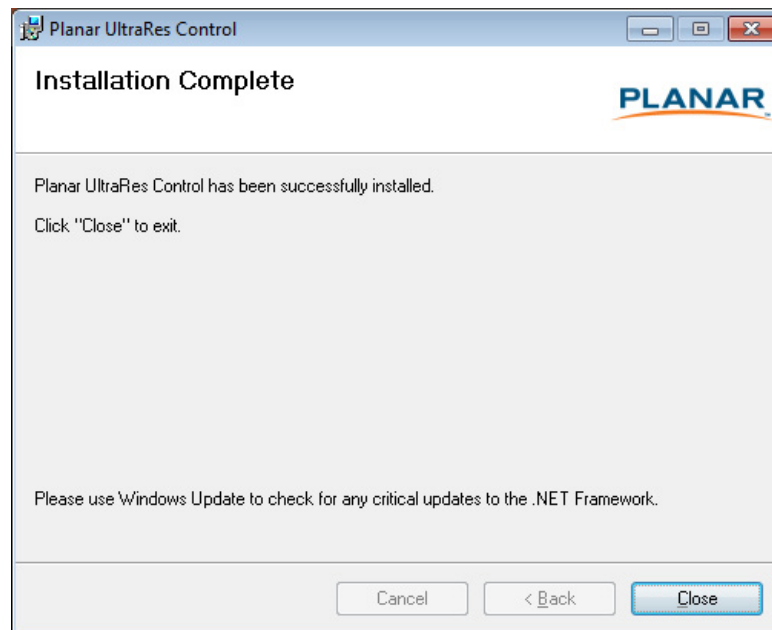

Installing USB Drivers

When you install the UltraRes Control software, it will automatically install the necessary USB drivers needed for communication between your computer and to the UltraRes display. You only need to complete a few steps to finish the installation process.

- 1 Plug one end of the USB cable into your computer and the other into the UltraRes display.
- 2 Windows will detect the new hardware and attempt to install the drivers. If this occurs, you should see a message similar to the following example.

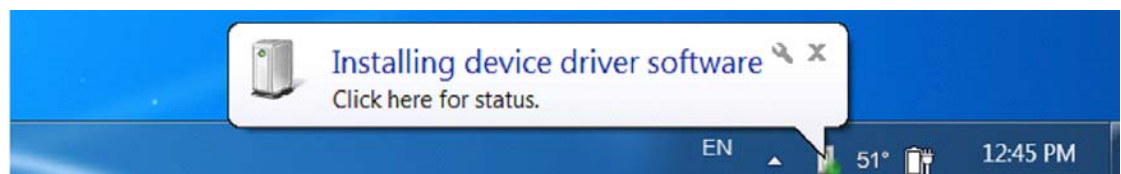

- 3 If the USB driver installation is successful, you will see a message similar to the example below. You are now done with the USB driver installation process.

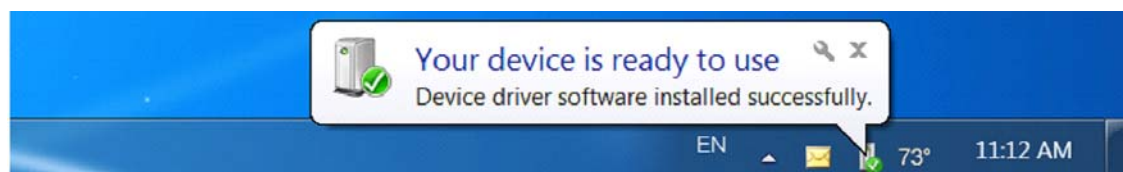

Using the UltraRes Control Software

When you first open the UltraRes Control software, you will see a window similar to the following. Notice that until you connect the inputs to the display, the “Status” at the top of the window will show “Disconnected.”

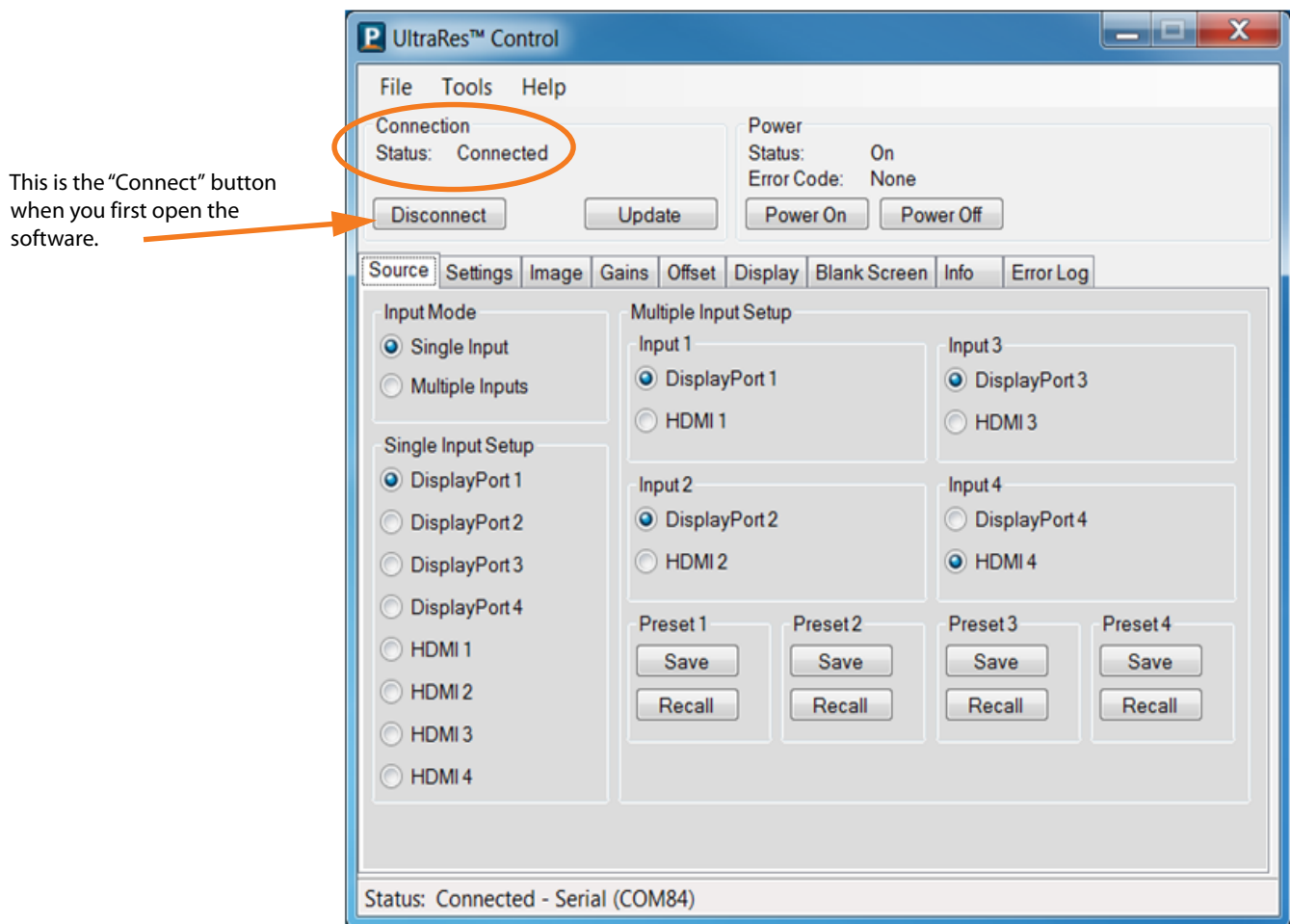

- 1 Connect from the PC on which the software is installed to the UltraRes display using a USB connection.
- 2 Click the **Connect** button to start the connection process.

- 3 The tool will then attempt to auto detect any inputs that are already connected. One of the following will occur:
 - If an input is detected, the following window appears with information already filled in.

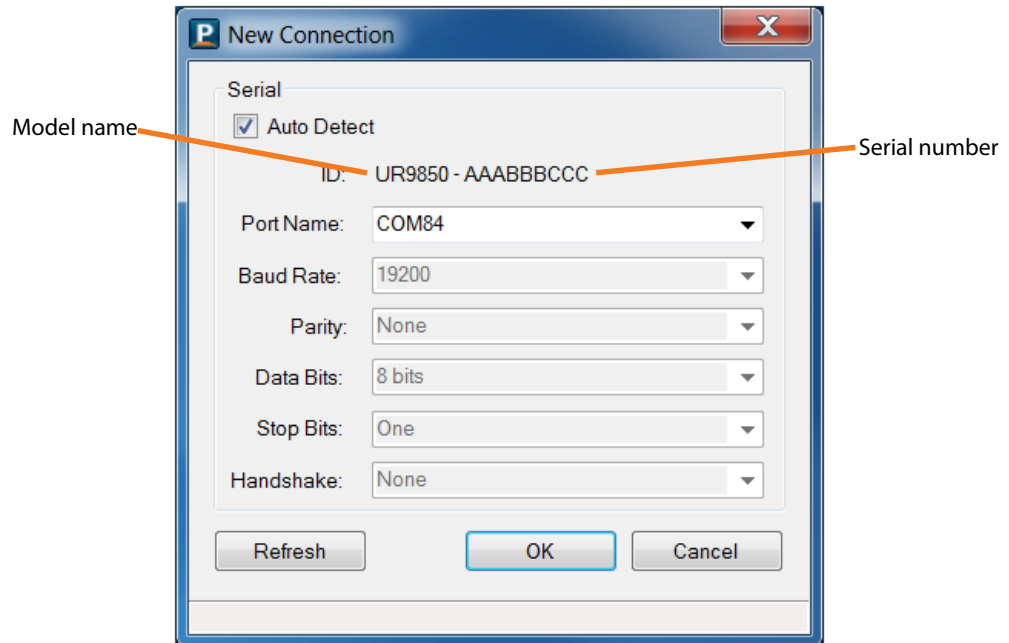

- If no input is auto-detected, you will see a window similar to the following. Notice all fields are grayed out and cannot be changed.

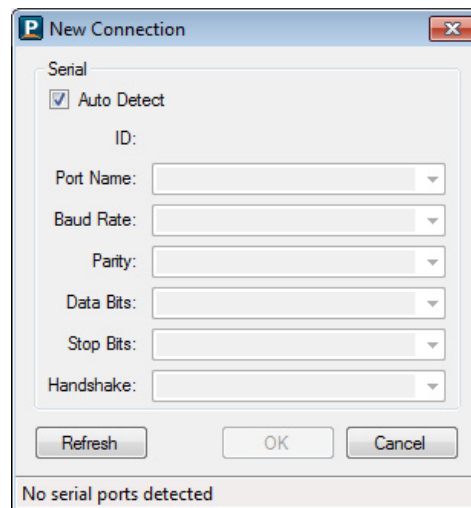

- 4 If the connection is successful, the "Status" at the top of the window will show "Connected." Note that all tabs are now accessible and can now be changed if needed.

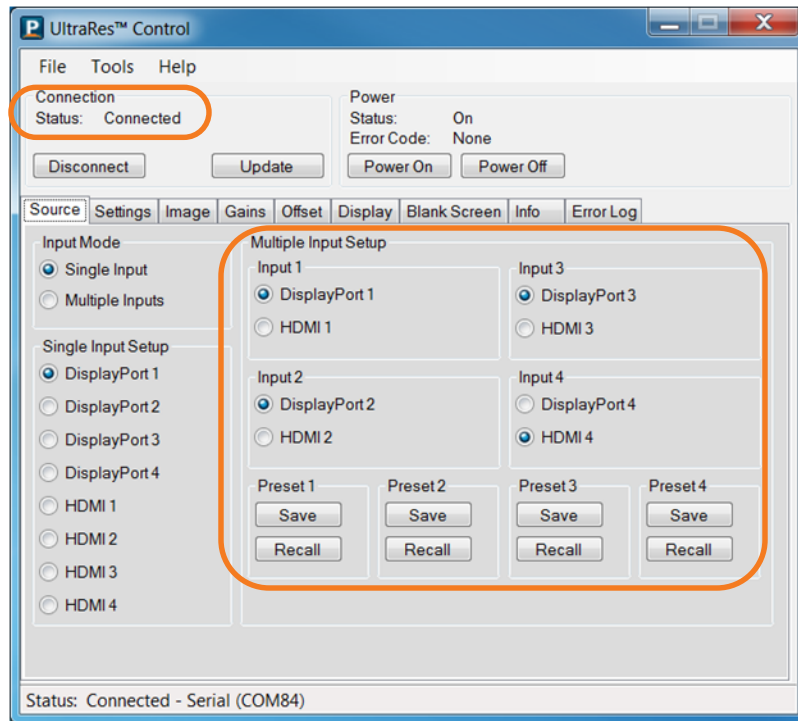

Setting Up Sources

This information is covered earlier in the manual. Please see "Setting up for Single Input Sources" on page 40 or "Setting up for Multiple Input Sources" on page 42 for setup information.

Auto Power Off Timer

If there is no incoming source for a certain amount of time and you want to turn power off automatically, use the **Auto Power Off Timer** slider on the Settings tab and select between 1-60 seconds.

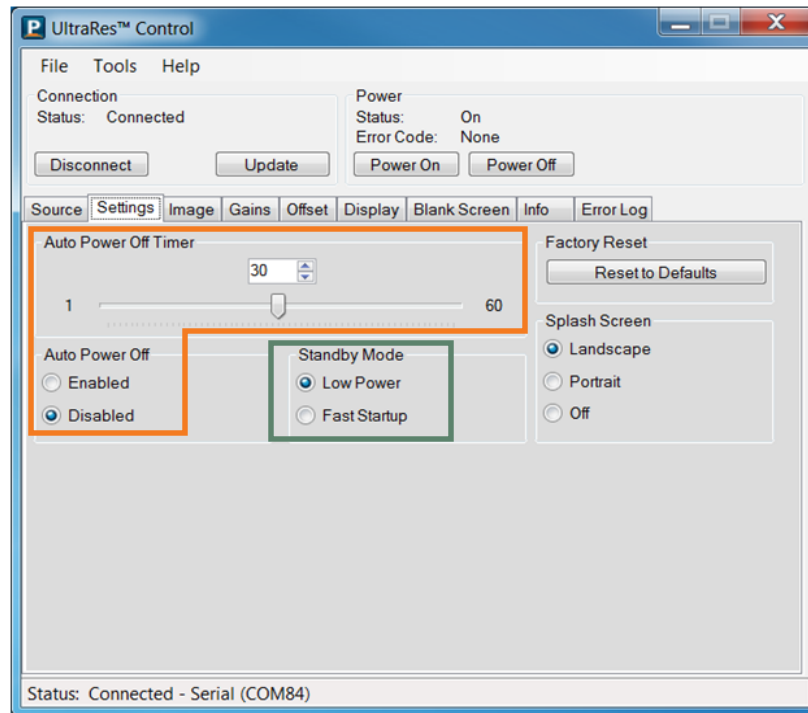

Standby Mode

Standby Mode allows you to choose between a low power setting, which saves energy, or a “fast startup” mode that keeps the AC power supplies running. Each option is described below.

- **Low Power** - Powers off every component and board possible, which helps conserve energy. In standby mode, the low power option only uses 0.5W of power.
- **Fast Startup** - Keeps AC power supplies running and takes a little less time to power up. If you intend to continually use networking capabilities, select this option.

Note: Fast Startup mode is *required* if you are using the network connection.

Splash Screen

Under the SETTINGS tab, you can select whether or not to display a Splash Screen. Choose LANDSCAPE or PORTRAIT to display the splash screen for five seconds, or OFF. The splash screen is only displayed when the Planar UltraRes is powering up.

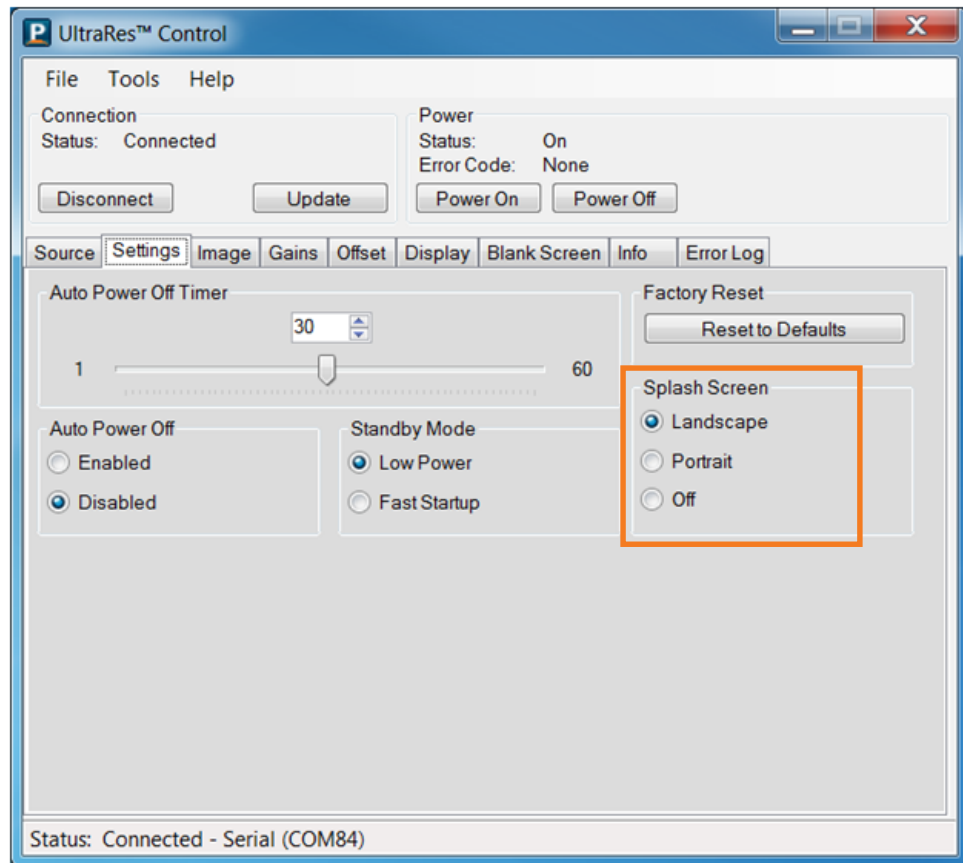

Order of Adjustment

It is good practice to adjust the image using the controls that follow in the order they are given.

Brightness

Use an external test pattern that has a PLUGE. This typically shows white and black chips and several gray chips in between.

Adjust the **Brightness** control until the **black** chip disappears into the background. The darkest Gray chip should be just visible above this background.

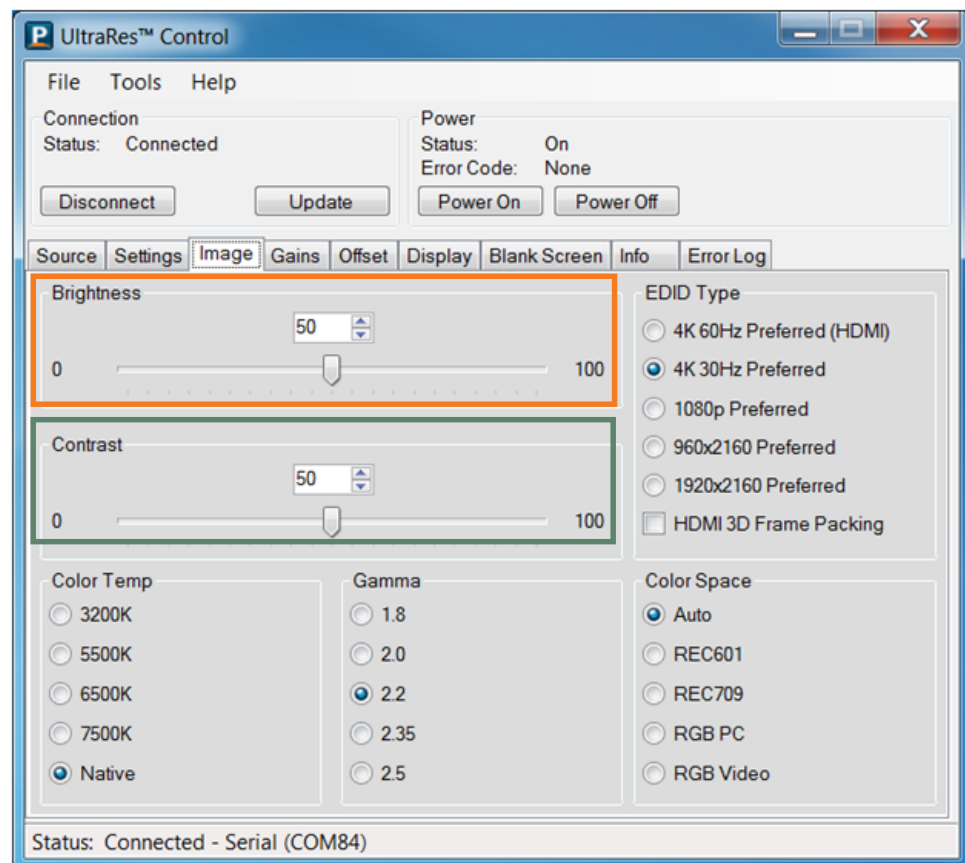

Contrast

Adjust **Contrast** so the two whitest chips are separately visible and the two darkest chips are separately visible. You should now be able to see the separation of all the chips.

Color Temperature

Color Temp determines how “warm” or “cool” the colors are overall. This control adjust all the colors, including white, but does not affect the Brightness or Contrast settings. A Color Temperature of 6500K is approximately the colors you see in bright sunlight outdoors. The 3200K settings is the colors you see in incandescent light. “Native” uses the color temperature of the display itself with no adjustment.

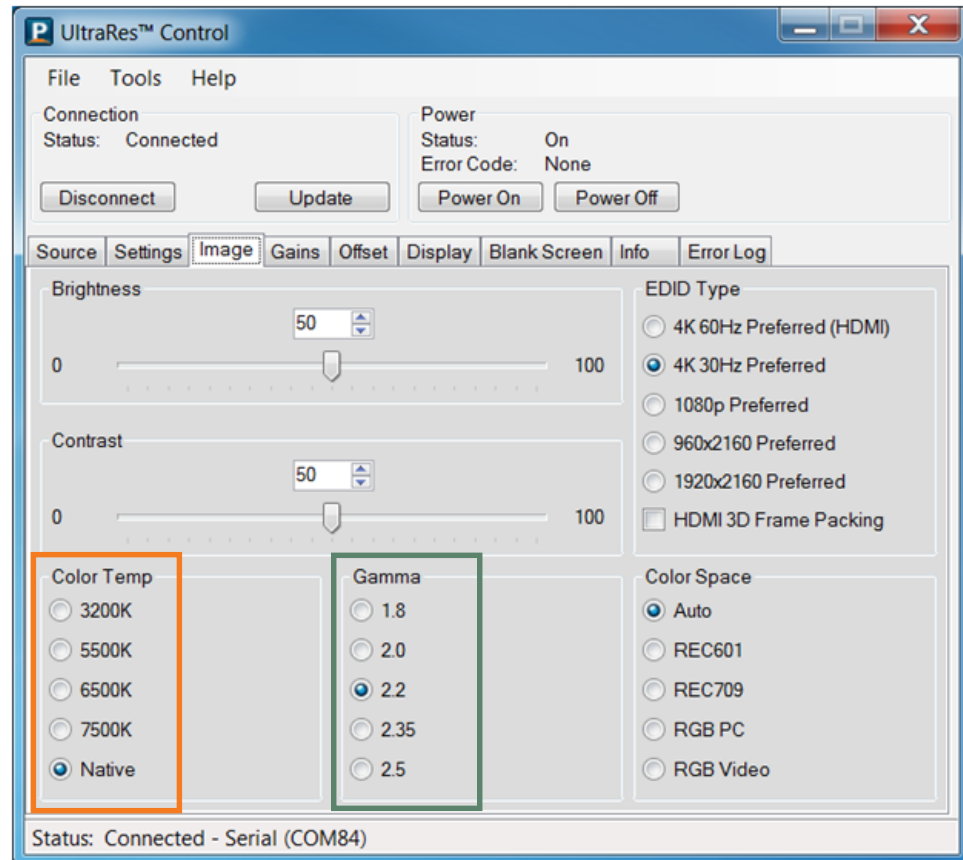

Gamma

Gamma is a curve of the brightness and contrast that, used correctly, can improve the separation and detail in the whites and blacks. If excess ambient light washes out the image and it becomes difficult or impossible to see details in dark areas, lower the gamma setting (smaller number) to compensate. This improves contrast while maintaining good details for blacks. Conversely, if the image is washed out and unnatural, with excessive detail in black areas, increase the setting.

EDID Type

EDID Type selects the preferred timing indicated in the EDID for the current input source:

- 4K 60Hz Preferred (HDMI): Selects an EDID with 4K @ 60Hz 4:2:0 as the default timing. Not applicable on DisplayPort.
- 4K 30Hz Preferred: Selects an EDID with 4K @ 30Hz as the default timing.
- 1080p Preferred: Selects an EDID with 1080p @ 60Hz as the default timing.
- 960x2160 Preferred: Selects an EDID with 960x2160 @ 60Hz as the default timing.
- 1920x2160 Preferred: Selects an EDID with 1920x2160 @ 60Hz as the default timing.

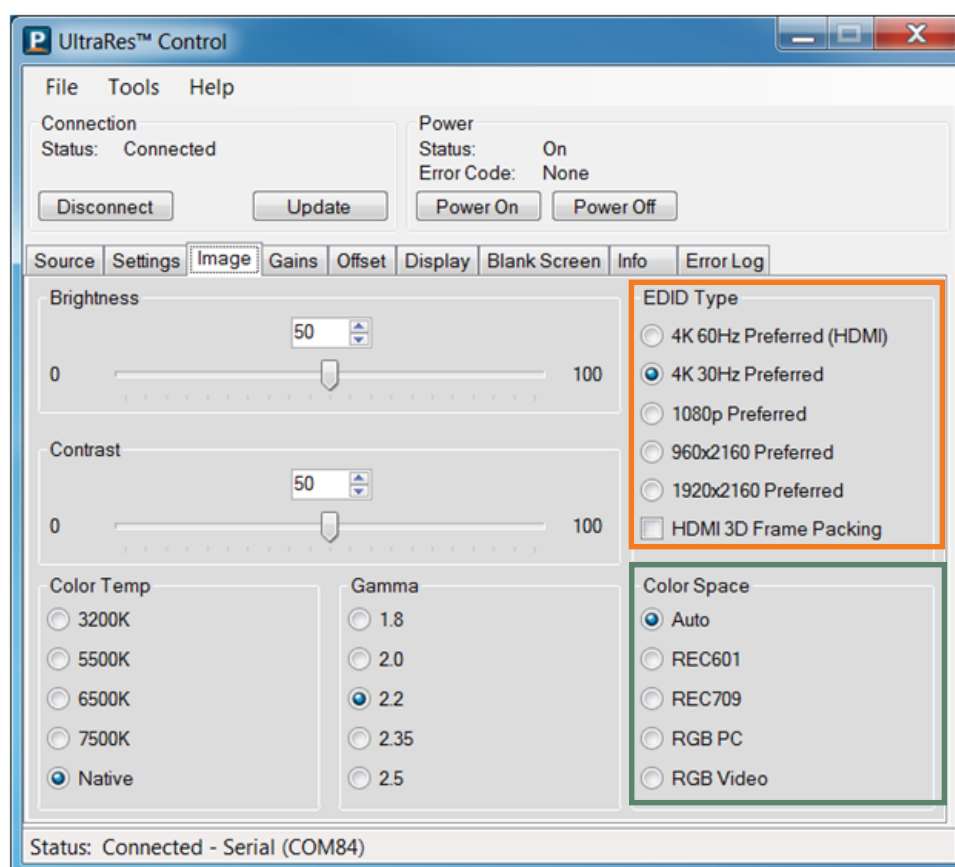

HDMI 3D Frame Packing

When checked, all HDMI EDIDs will indicate support for 3D frame packing formats, which are commonly used by 3D Blu-ray players. Note that side-by-side and top-and-bottom 3D formats are not supported.

Color Space

Color Space selects the color space of the source signal for HDMI, RGB, and component connections. In most cases, the Auto setting determines the correct color space to use. If it does not, you can force the Planar UltraRes to use a specific color space.

Choose one of the following:

- REC601 sets the color space matrix to that defined in ITU-R BT.601.
- REC709 sets the color space matrix to that defined in ITU-R BT.709.
- RGB PC uses RGB color space and sets black at 0,0,0 RGB and white at 255,255,255 RGB, assuming an 8-bit image.
- RGB Video uses RGB color space and sets black at 16,16,16 RGB and white at 235,235,235, assuming an 8-bit image, to correspond to the luminance values defined in digital component standards.

Gain

The Gains tab adjusts for color imbalance in the bright areas. A good way to do this is to use a test pattern consisting mostly of solid white areas. If the white areas contain traces of red, green or blue, decrease the Gain for that color.

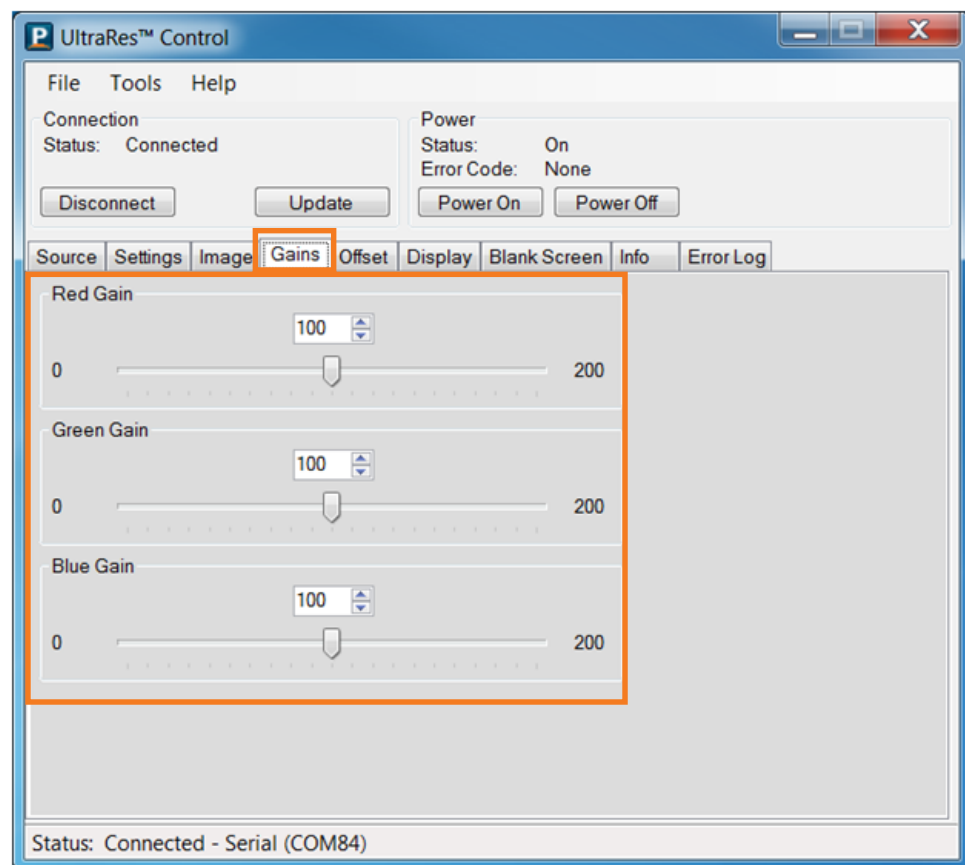

Offset

The Offset tab corrects for color imbalances in the dark areas of the image. A good way to do this is to use a test pattern consisting mostly of dark gray areas, such as a 30 IRE “window” pattern. If the gray areas contain traces of red, green, or blue, decrease the Offset for that color. Do the Gain adjustment first, then the Offset.

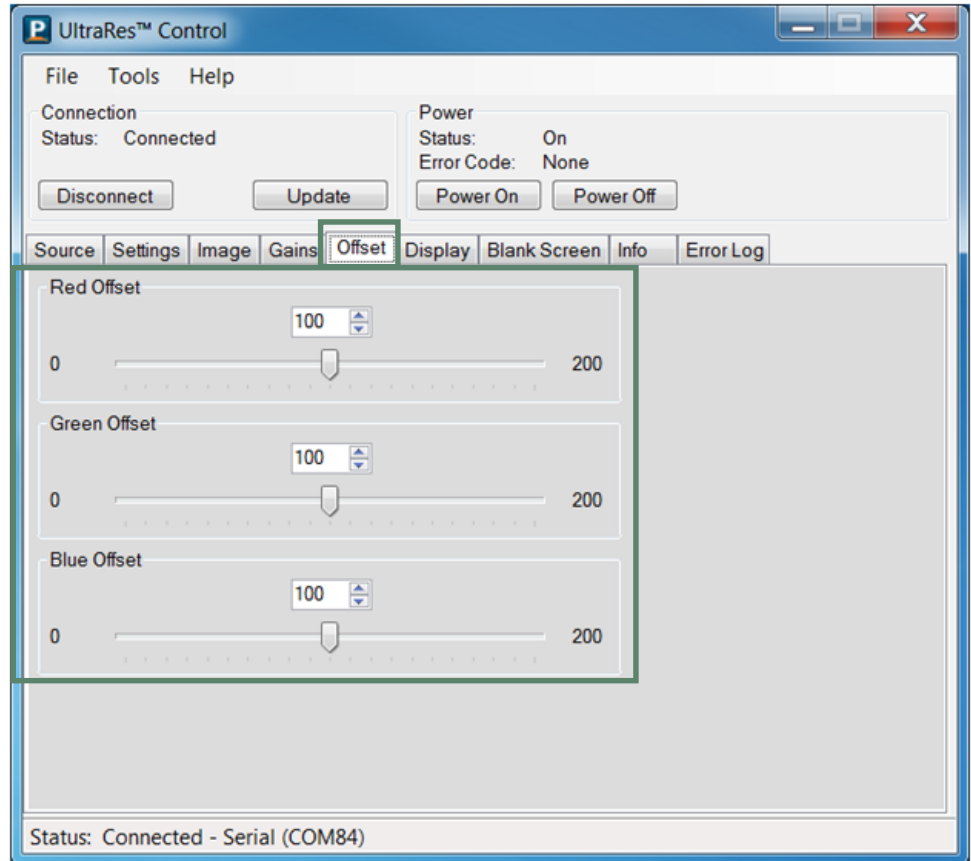

Changing Backlight Intensity

To change the brightness of the display, use the **Backlight** control on the Display tab. If you want a brighter display, move the slider towards a higher number. If you want to conserve power and increase backlight life, move the slider towards a lower number.

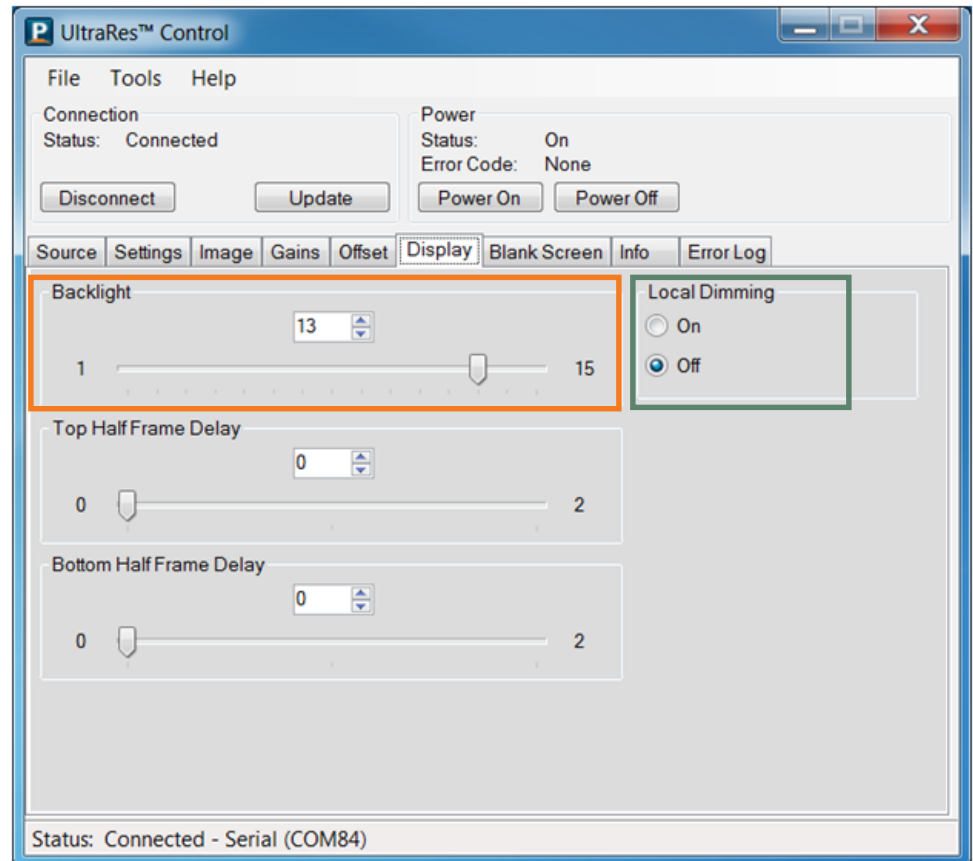

Turning Local Dimming On or Off

Local Dimming allows the LED edge lighting to adjust dynamically depending on the content of the source. Turning this feature on shows darker black levels, which in turn has a higher contrast ratio.

Changing Frame Delay

With some quadrant sources, the top and bottom halves of display can show frame tearing, at a delay of one frame per second. If you see frame tearing, use the **Top Half Frame Delay** and **Bottom Half Frame Delay** sliders to compensate.

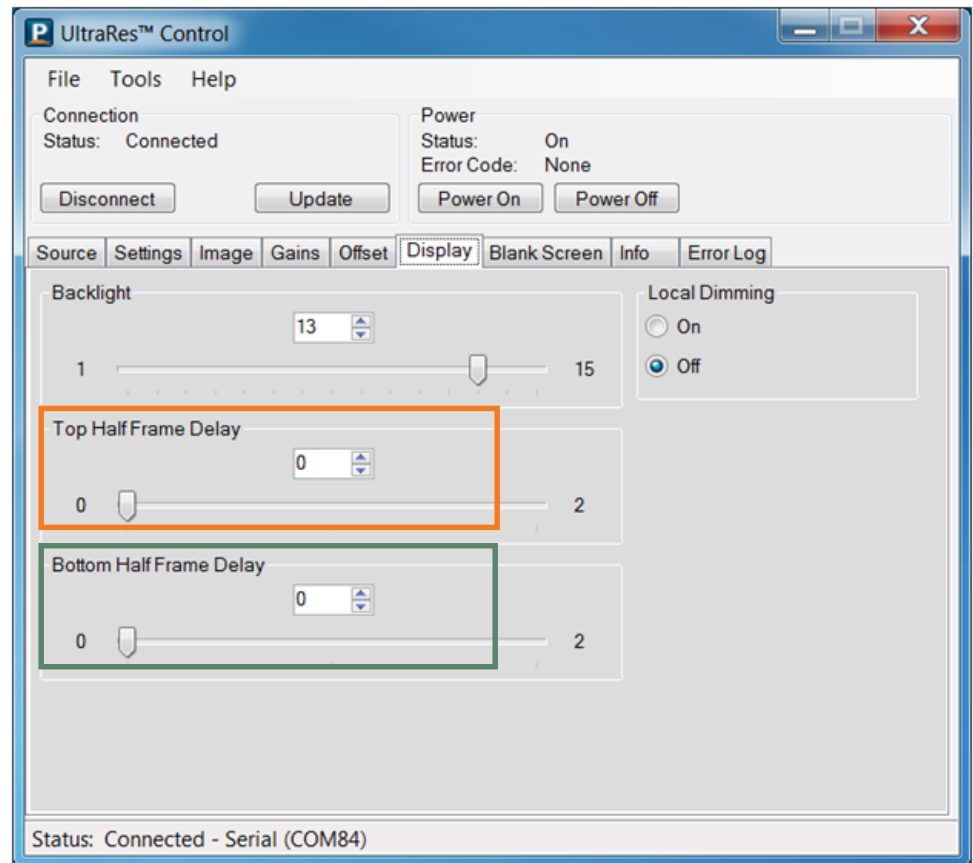

Upgrading Firmware

Upgrading firmware can only be done through the UltraRes Control software using a USB connection.

- 1 Select the FILE menu bar and then UPGRADE FIRMWARE.

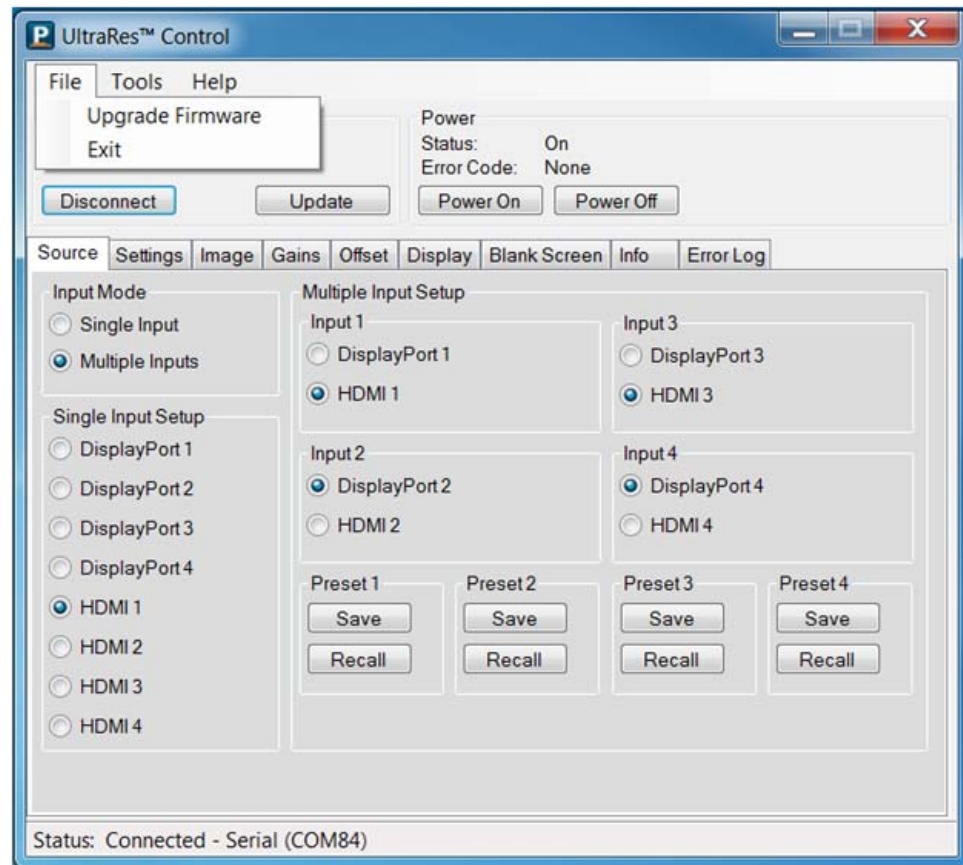

- 2 A file called **4K.xml** will be part of the release package. Navigate to this section and click **Open** to begin the upgrade process.

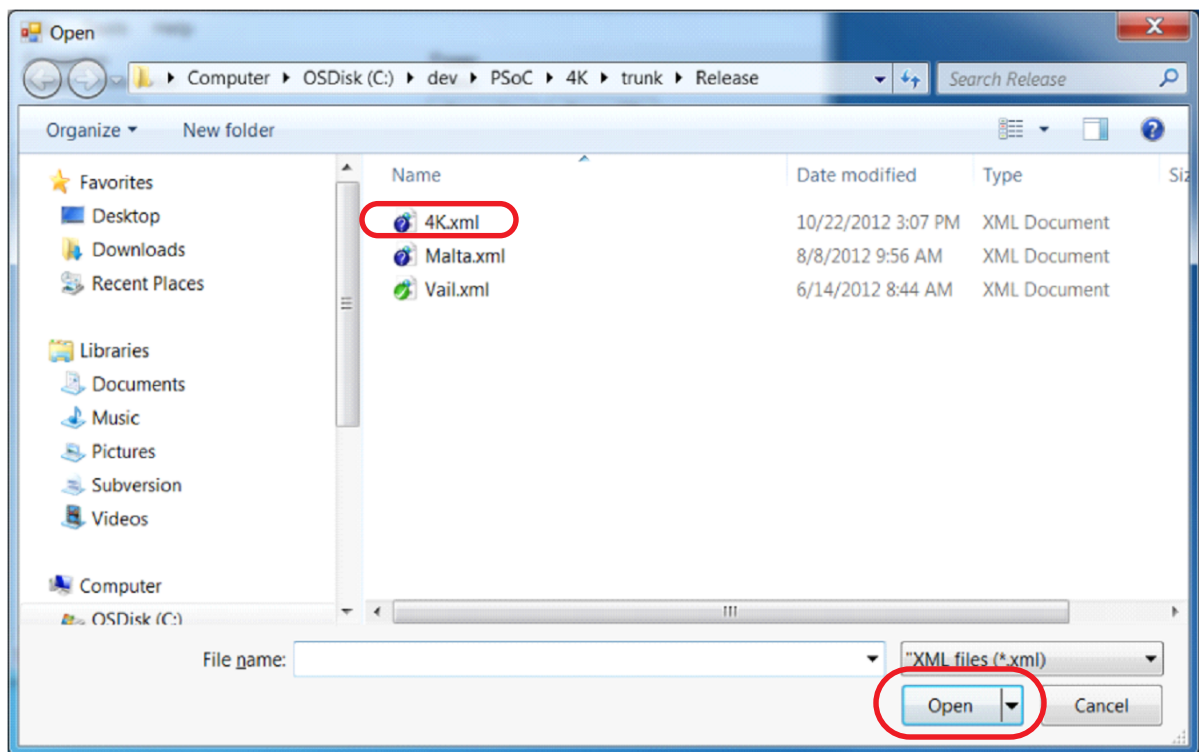

Note: The upgrade can be initiated from ON or standby mode.

- 3 The upgrade process will take about **40 minutes**. Be sure you are prepared for this amount of time before you initiate the upgrade process.
- 4 The upgrade process status bar will show where you are in the upgrade process as it proceeds.
- 5 When the upgrade is complete, you will see a message box similar to the following example.

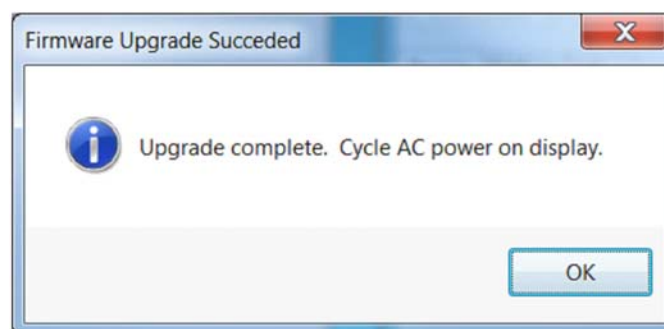

Error Log

To see the last 50 errors that have occurred, select the Error Log tab in the UltraRes Control software, as shown below. For a complete list of the error codes, see "Error Codes in the UltraRes Control Software" on page 142.

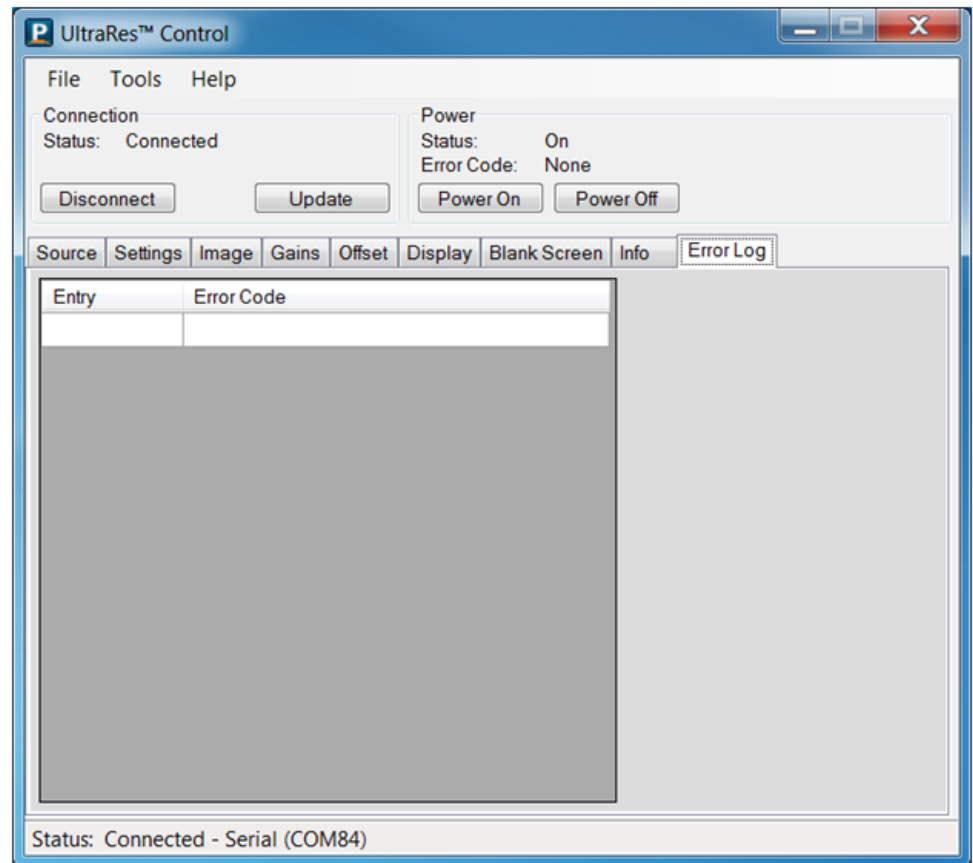

Network Settings

DHCP Network Setup

- 1 Turn on the display.
- 2 Open the UltraRes Control tool and connect to the display.
- 3 Select the Info tab. The IP address is shown towards the bottom of the tab.

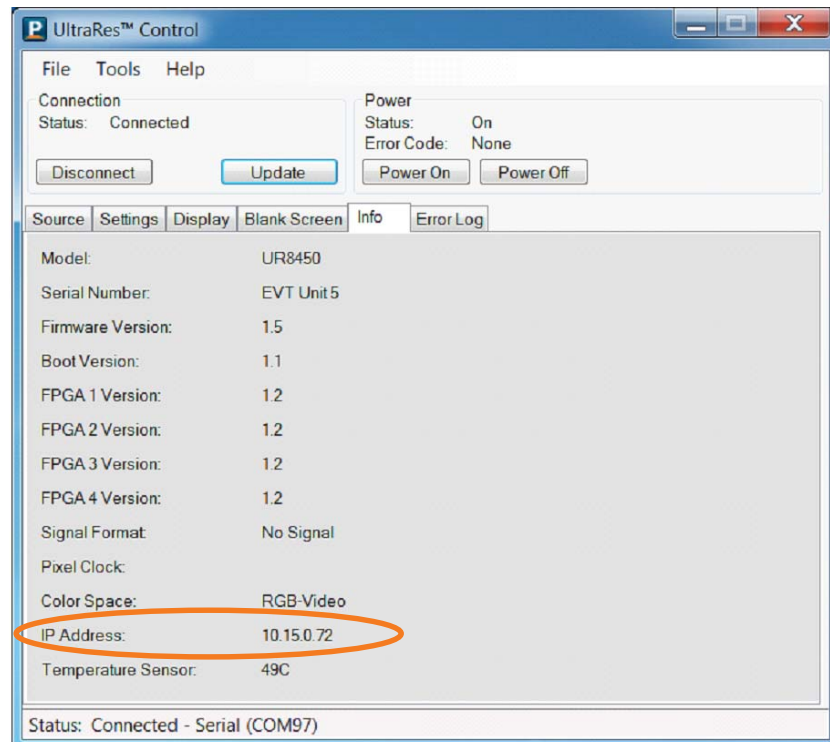

- 4 One of the following will occur:
 - If the IP address is 192.168.12.12, then DHCP failed. Use the Static IP Network Setup instructions in the following section.

Note: Fast Startup mode is required if you are using the network connection.

- 5 If the IP address shows anything else, then DHCP succeeded. To confirm the connection, open a Windows command prompt and use the “ping” command with the IP address shown in UltraRes Control.

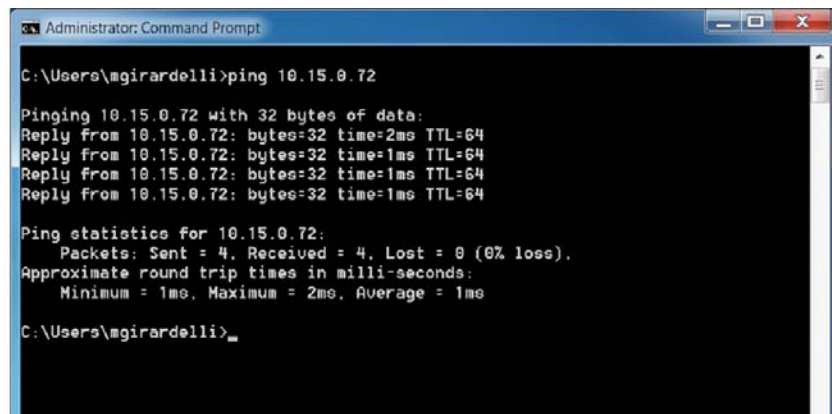
A screenshot of a Windows Command Prompt window titled "Administrator: Command Prompt". The window shows the execution of the command "ping 10.15.0.72". The output displays four successful replies from 10.15.0.72, each with 32 bytes of data, a time of 1ms or 2ms, and a TTL of 64. Below the replies, the ping statistics are shown: "Ping statistics for 10.15.0.72: Packets: Sent = 4, Received = 4, Lost = 0 (0% loss), Approximate round trip times in milli-seconds: Minimum = 1ms, Maximum = 2ms, Average = 1ms". The prompt ends with "C:\Users\mgirardelli>".

```
Administrator: Command Prompt
C:\Users\mgirardelli>ping 10.15.0.72
Pinging 10.15.0.72 with 32 bytes of data:
Reply from 10.15.0.72: bytes=32 time=2ms TTL=64
Reply from 10.15.0.72: bytes=32 time=1ms TTL=64
Reply from 10.15.0.72: bytes=32 time=1ms TTL=64
Reply from 10.15.0.72: bytes=32 time=1ms TTL=64

Ping statistics for 10.15.0.72:
    Packets: Sent = 4, Received = 4, Lost = 0 (0% loss),
    Approximate round trip times in milli-seconds:
        Minimum = 1ms, Maximum = 2ms, Average = 1ms

C:\Users\mgirardelli>
```

Note: If you cannot confirm a connection, check with your Network Administrator for more information.

Static IP Network Setup

If DHCP is unsuccessful, the Remote Monitoring Ethernet interface defaults to a static IP address of 192.168.12.12/24.

- 1 The PC must be configured to an IP address on the 192.168.12 network. We recommend 192.168.12.100.
- 2 Assuming the operating system is Windows 7, you can follow these instructions to configure the PC network interface.
- 3 On the PC, select **Start, Control Panel** and choose the **View by** dropdown in the top right corner of the window. Choose large icons or small icons.

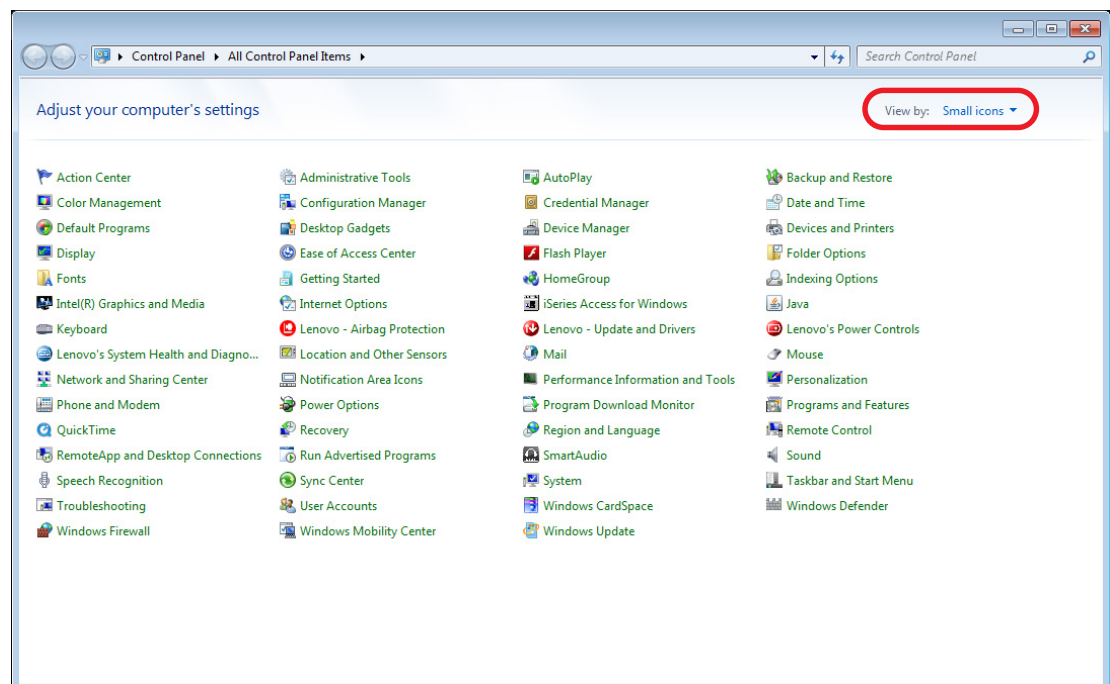

4 Open **Network and Sharing Center**.

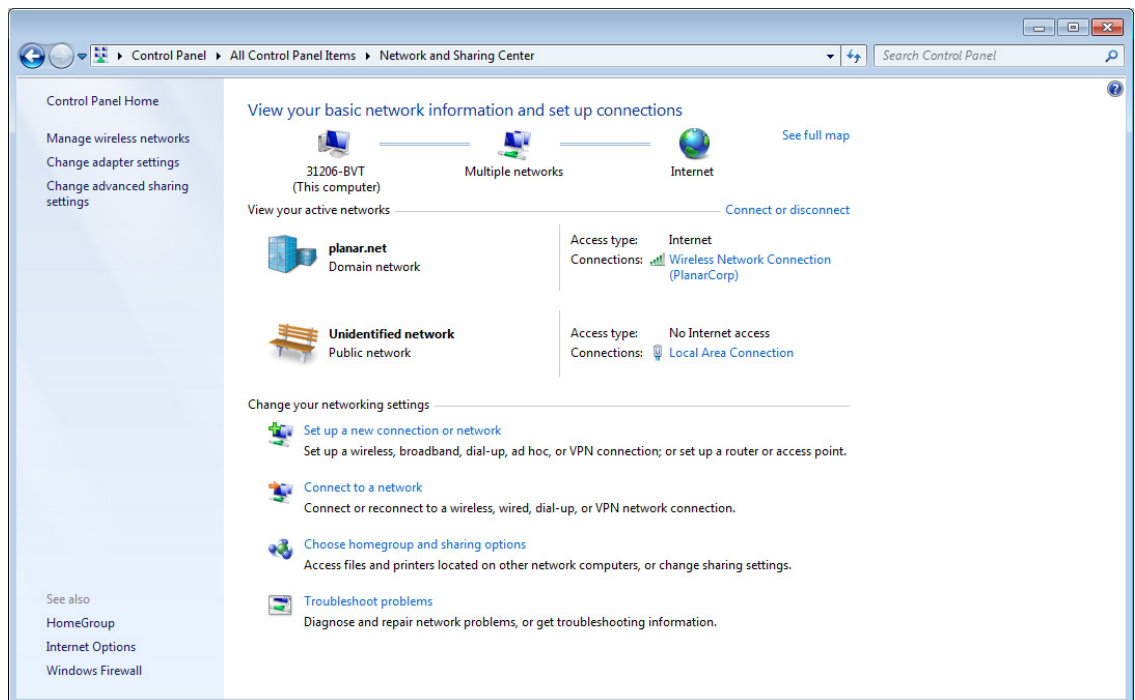

5 Click **Change adapter settings** in the left side pane.

6 Right-click on the local area connection that corresponds to the network interface that is connected to the UltraRes and then select **Properties**.

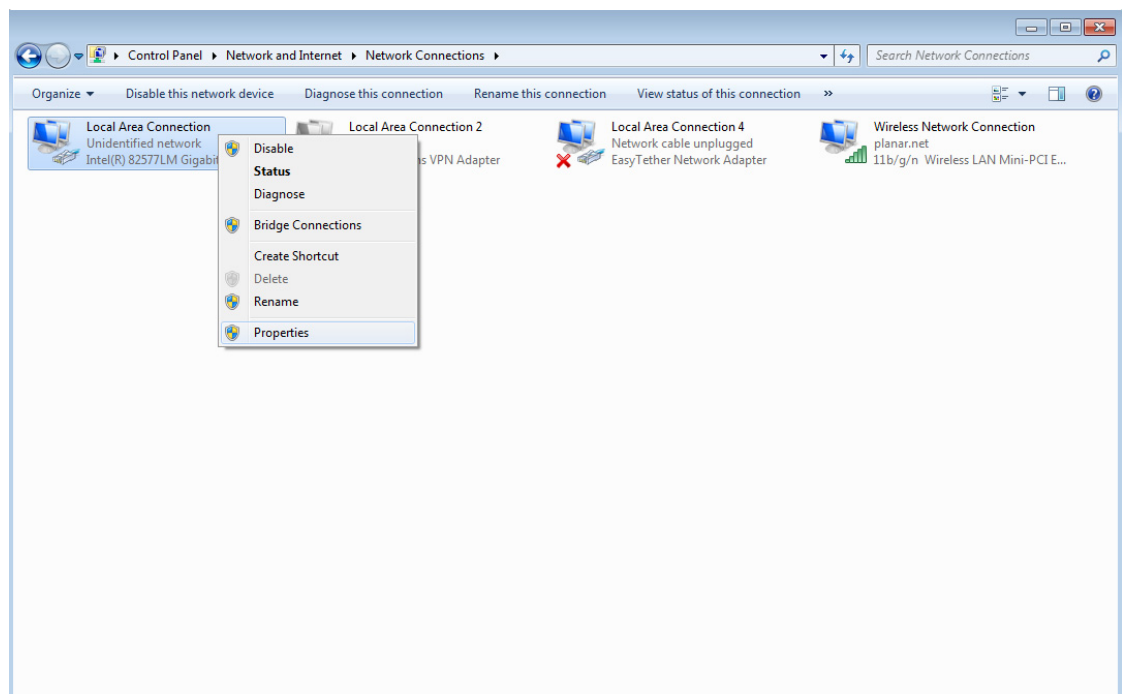

- 7 Select **Internet Protocol Version 4 (TCP/IPv4)** and then click the **Properties** button.

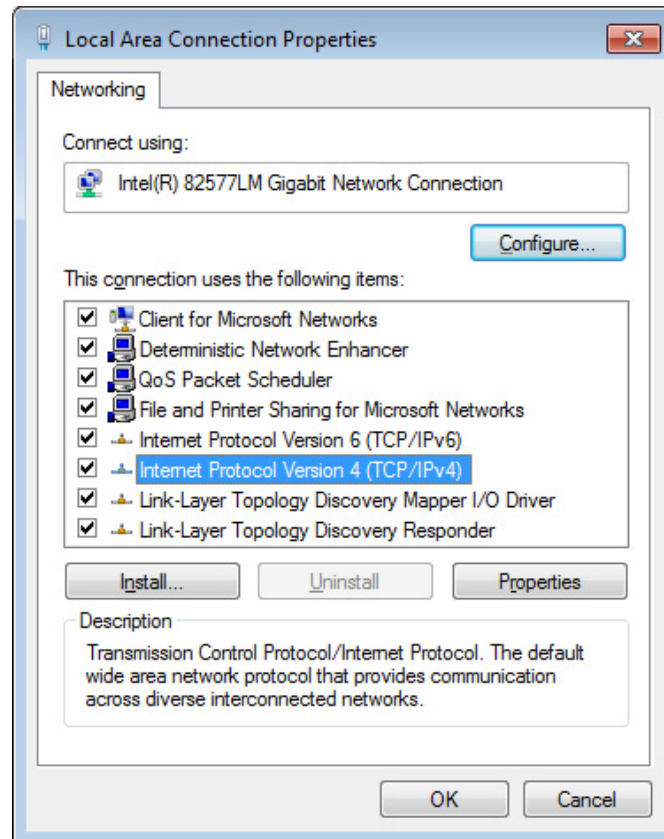

- 8 Select the **Use the following IP address** radio button and then enter 192.168.12.100 for the **IP address**, 255.255.255.0 for the **Subnet mask** and 192.168.12.1 for the **Default gateway**. Click **OK** to dismiss the IPv4 Properties window. Then click **Close** to dismiss the **Local Area Connection Properties** window.

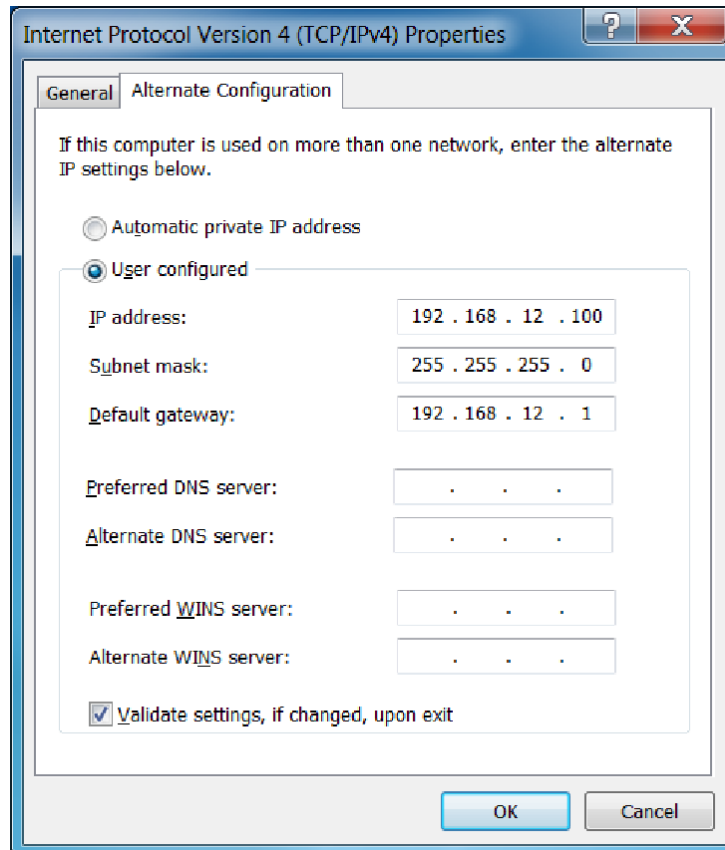

- 9 To confirm the connection, open a Windows command prompt and enter **ping 192.168.12.12**, as shown below.

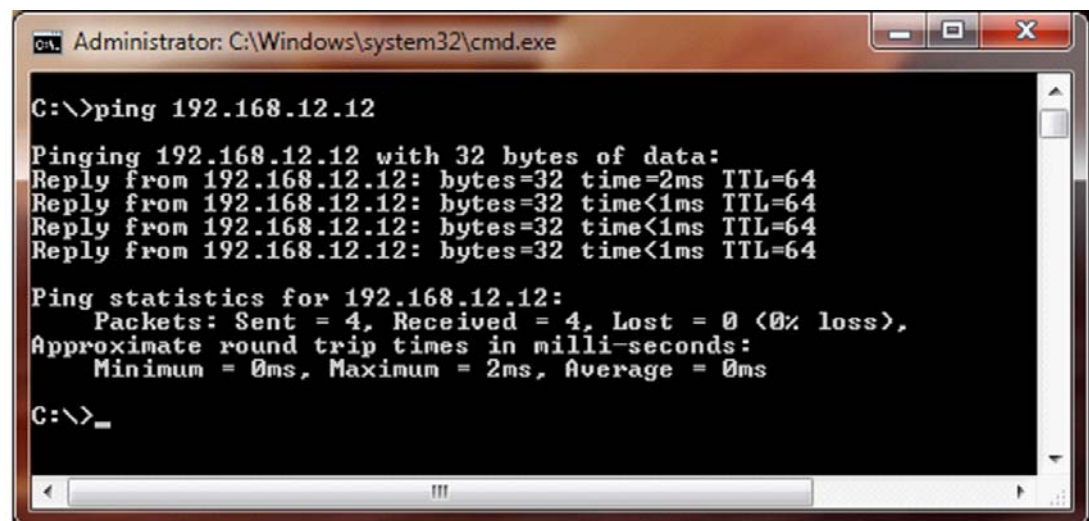
The image shows a Windows command prompt window titled "Administrator: C:\Windows\system32\cmd.exe". The prompt is at "C:\>". The user has entered the command "ping 192.168.12.12". The output is as follows:

```
C:\>ping 192.168.12.12

Pinging 192.168.12.12 with 32 bytes of data:
Reply from 192.168.12.12: bytes=32 time=2ms TTL=64
Reply from 192.168.12.12: bytes=32 time<1ms TTL=64
Reply from 192.168.12.12: bytes=32 time<1ms TTL=64
Reply from 192.168.12.12: bytes=32 time<1ms TTL=64

Ping statistics for 192.168.12.12:
    Packets: Sent = 4, Received = 4, Lost = 0 (0% loss),
    Approximate round trip times in milli-seconds:
        Minimum = 0ms, Maximum = 2ms, Average = 0ms

C:\>_
```

Planar UltraRes Remote Monitoring Software

Planar UltraRes Remote Monitoring is a software tool that displays information about the display via a web browser. It is used primarily for monitoring, reporting and some control (for example, manually powering the displays on and off).

Remote Monitoring Home

Launch a web browser. If you are using DHCP, enter in the IP address shown on the Info tab of UltraRes Control. If you are not using DHCP, enter <http://192.168.12.12> in the address bar. For either web address entered, you should see a page similar to the following.

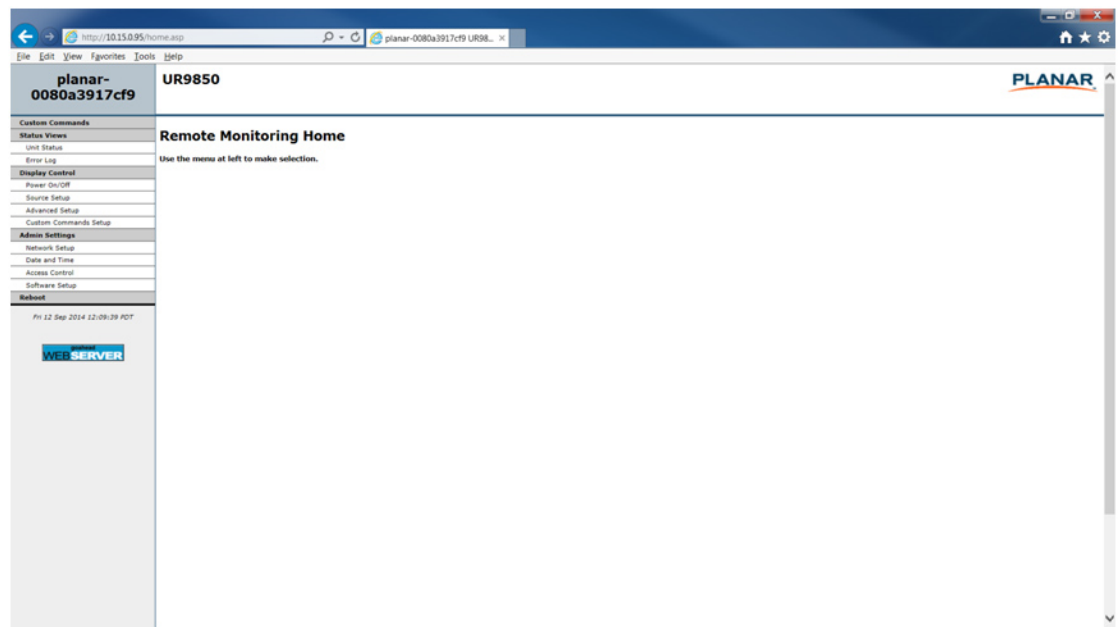

Remote Monitoring Custom Commands

The Custom Commands page enables you to execute custom serial commands. You define these commands on the Custom Commands Setup page.

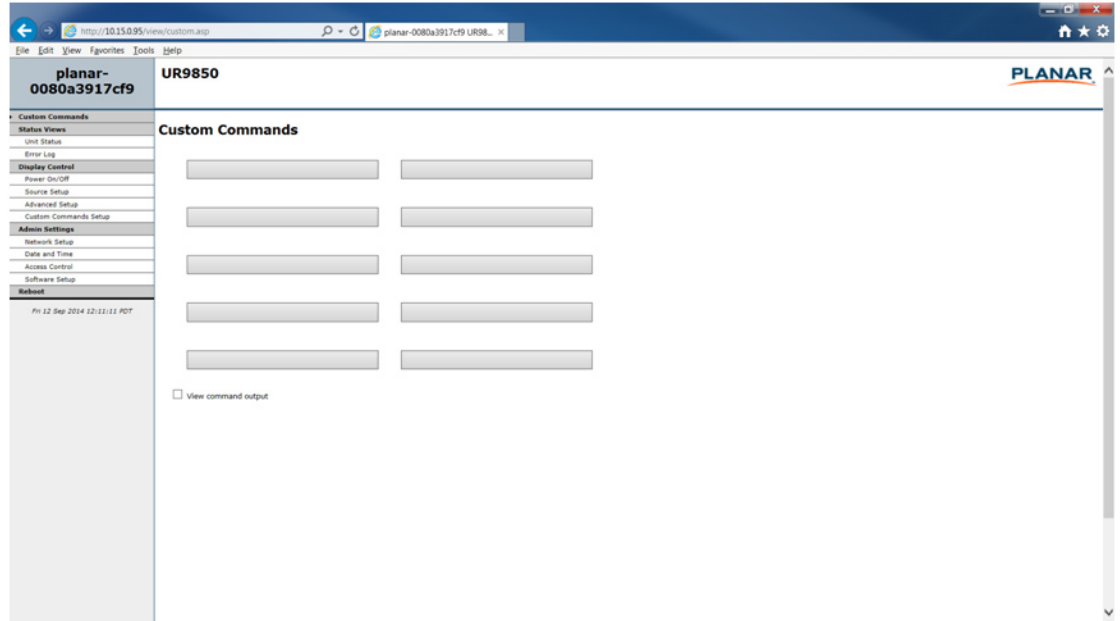

Remote Monitoring Unit Status

The Unit Status page shows a list of the different system settings for the display, including power, signal format and which sources are connected with which inputs. It also shows all current firmware information, the display ID and the serial number of the specific display.

The screenshot displays the 'Unit Status' page for a Planar UR9850 display. The browser window shows the URL 'http://10.15.0.95/view/brief.asp' and the device identifier 'planar-0080a3917cf9 UR9850'. The page is organized into a sidebar and a main content area. The sidebar includes sections for 'Status Views' (Unit Status, Error Log), 'Display Control' (Power On/Off, Source Setup, Advanced Setup, Custom Commands Setup), 'Admin Settings' (Network Setup, Date and Time, Access Control, Software Setup), and 'Reboot' (with a timestamp 'Fri 12 Sep 2014 12:11:29 PDT'). The main content area is titled 'Unit Status' and contains two primary sections: 'Display Status' and 'Display ID'. The 'Display Status' section lists the following parameters: Display Power: On, Status: On, Backlight: 15, Signal Format: No Signal, Input Mode: Single, Input Source: DisplayPort 1, Multiple Input 1: DisplayPort, Multiple Input 2: Based on Input Source, Multiple Input 3: Based on Input Source, Multiple Input 4: Based on Input Source, Color Space: RGB, Pixel Clock: NA, Local Dimming: Enabled, Standby Mode: Low Power, and Auto Power Off: Enabled. The 'Display ID' section lists: Model: UR9850, Firmware Version: 2.3A, Boot Version: 1.1, FPGA 1 Version: 1.6.1, FPGA 2 Version: 1.6.1, FPGA 3 Version: 1.6.1, FPGA 4 Version: 1.6.1, and Serial Number: EVT Unit #5.

Remote Monitoring Display Control

The Display Control page contains three sub-pages: Power On/Off, Source Setup and Advanced Setup. These are described in the following pages.

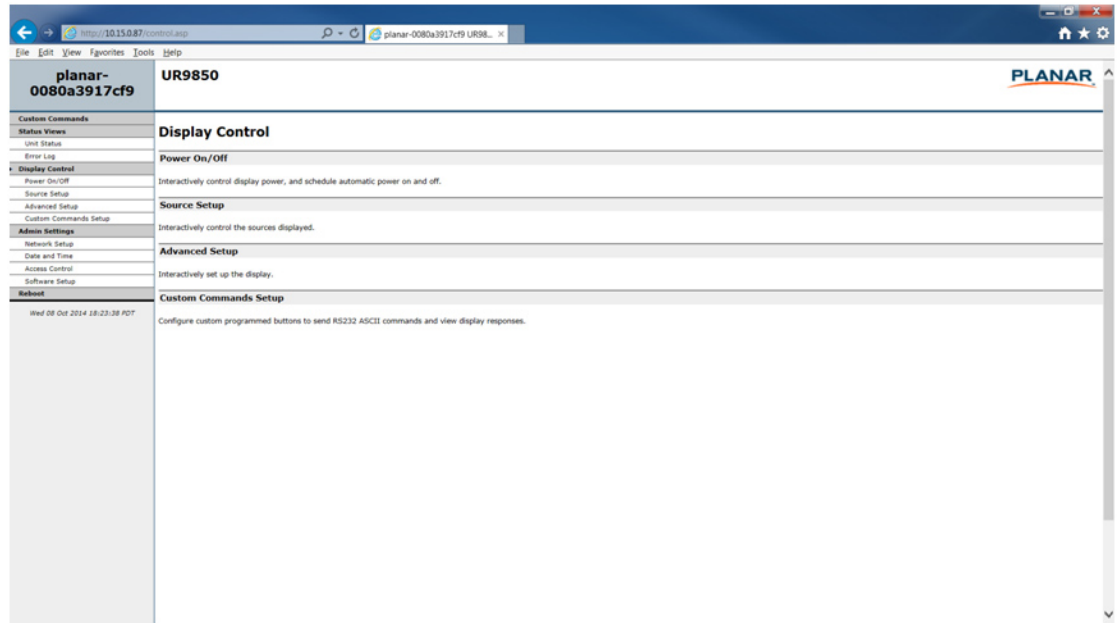

Remote Monitoring Power On/Off

Power On/Off buttons control the LED power, not the AC power. You cannot control AC power through Planar UltraRes Remote Monitoring.

This section has four options for which you can schedule an automatic power on/off. The options are:

- No automatic power on/off
- Same daily schedule
- Same Monday-Friday schedule and weekends off
- Each day has its own schedule. You can only select one of the schedule types.

Note: The default is **No automatic power on/off**.

The screenshot shows the web interface for a Planar UR9850 device. The browser address bar shows the URL `http://10.15.0.95/rip/power.asp`. The page title is "planar-0080a3917cf9 UR9850". The left sidebar contains a navigation menu with sections: Custom Commands, Status Views, Display Control, Admin Settings, and Reboot. The main content area is titled "Power On/Off" and features a "Power:" label with "On" and "Off" buttons. Below this is the "Schedule Automatic Power On / Off" section, which has four radio button options:

- No automatic power on / off
- Every day has the same schedule (with "On at:" and "Off at:" input fields)
- Monday-Friday have the same schedule, weekends off (with "On at:" and "Off at:" input fields)
- Each day has its own schedule (with a table of "On at:" and "Off at:" input fields for each day of the week)

 At the bottom of the main content area, there is a "Submit Changed Settings" section with a "Change Power On/Off Settings" button.

Remote Monitoring Source Setup

The Source Setup page allows you to perform the same tasks that you can using the Remote Monitoring software:

- Select single or multiple input mode
- Select an input source for each input in single input mode
- Select different options for inputs in multiple input mode

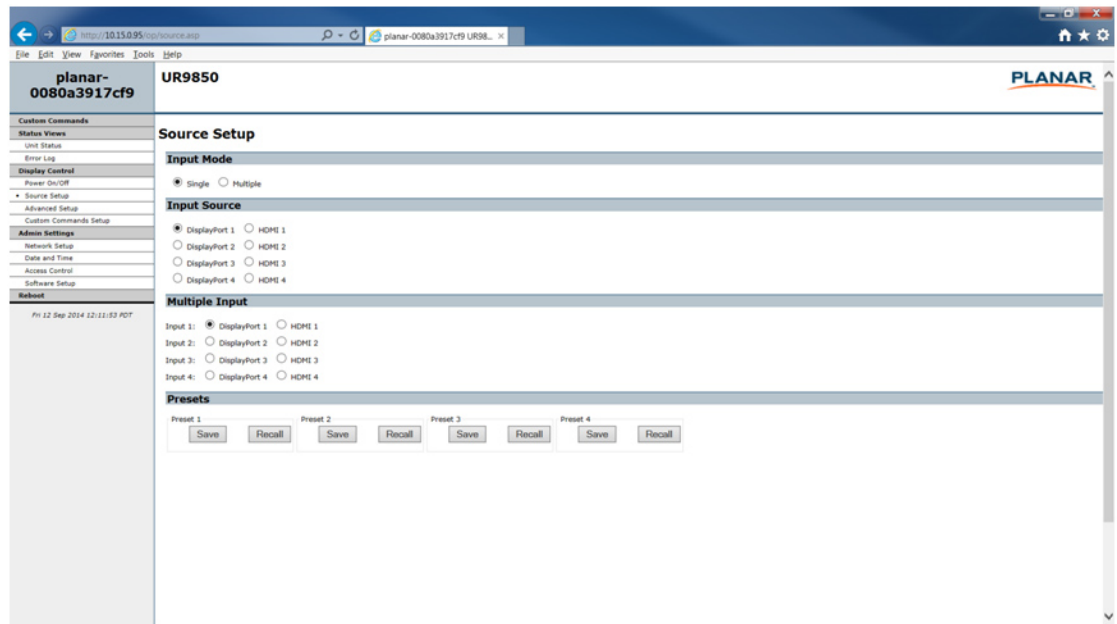

Remote Monitoring Advanced Setup

The Advanced Setup page allows you to perform many of the same tasks that you can on the UltraRes Monitoring software program. This includes selecting the power mode that works best for your display, either low power or fast startup. You can also select many display settings such as backlight intensity, frame delay, color space definitions and RGB settings.

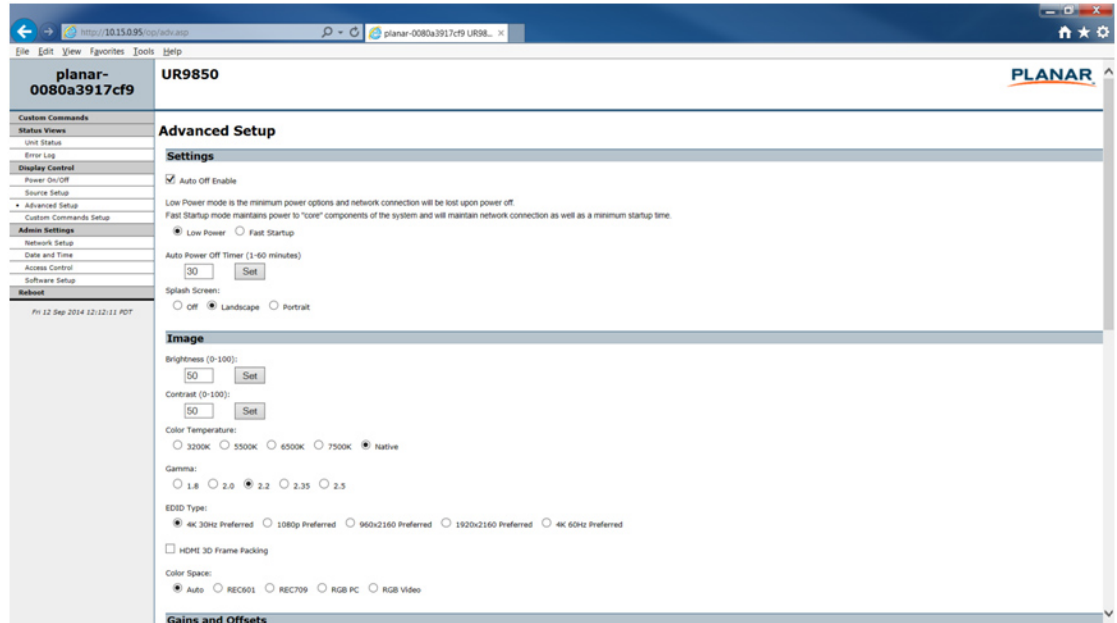

Remote Monitoring Custom Commands Setup

The Custom Commands Setup page enables you to create custom commands that you can execute from the Custom Commands page.

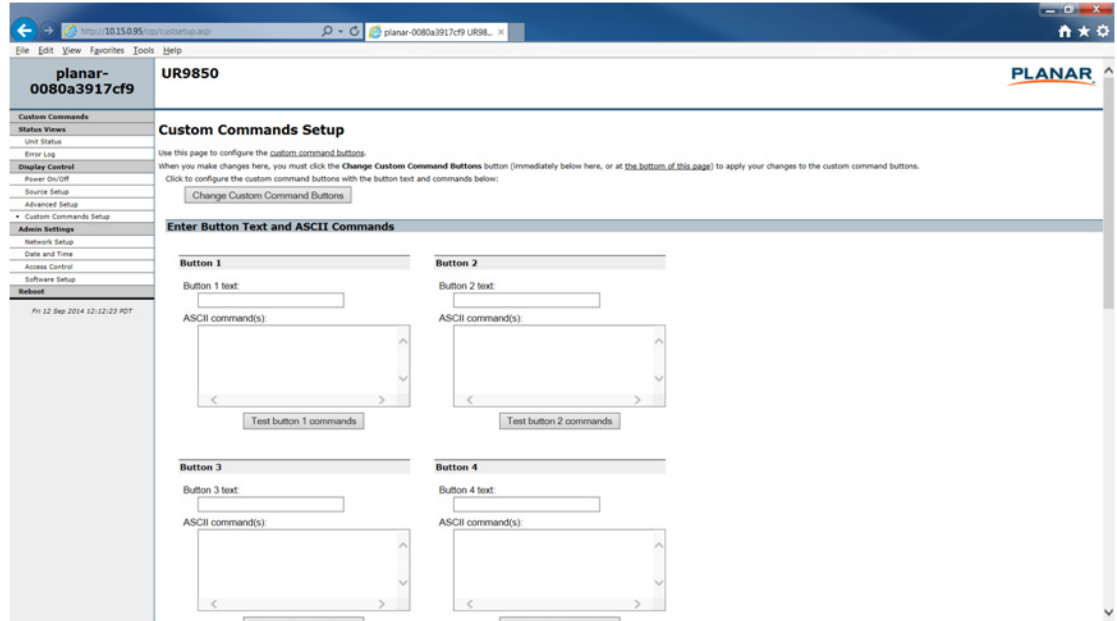

Remote Monitoring Admin Setup

The Admin Setup page contains four sub-pages: Network Setup, Date and Time, Access Control and Software Setup. These are described in the following pages.

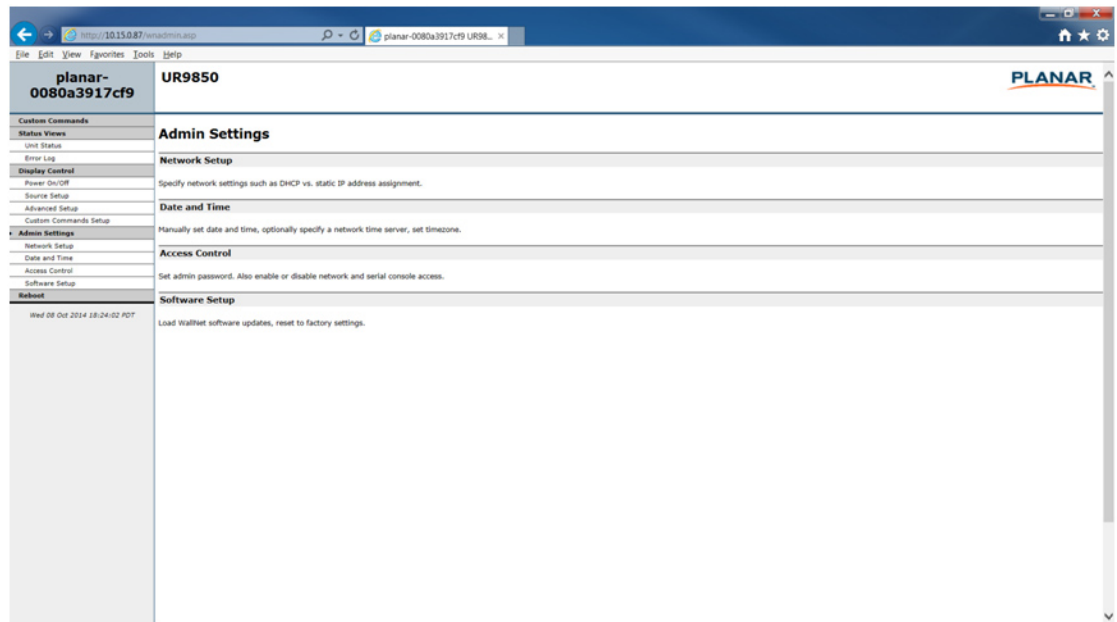

Remote Monitoring Network Setup

This page allows you to configure network settings and whether or not you use DHCP. For more information about setting up DHCP, see "DHCP Network Setup" on page 80.

The screenshot shows the 'Network Setup' page in a web browser. The browser address bar shows 'http://10.11.0.95/admin/networksetup.asp'. The page title is 'planar-0080a3917cf9 UR9850'. The left sidebar contains navigation options like 'Custom Commands', 'Status Views', 'Unit Status', 'Error Log', 'Display Control', 'Power On/Off', 'Source Setup', 'Advanced Setup', 'Custom Commands Setup', 'Admin Settings', 'Network Setup', 'Date and Time', 'Access Control', 'Software Setup', and 'Reboot'. The main content area is titled 'Network Setup' and includes the following sections:

- Hostname and Domain Name:** A text box for 'Hostname' containing 'planar-0080a3917cf9' and an empty 'Domain name' text box.
- DHCP:** A section with a note about DHCP requirements. It has two radio buttons: 'Yes, use DHCP' (selected) and 'No, use static settings'. Below is a 'DHCP timeout in seconds (min 5, max 120):' field with the value '20'.
- Static (non-DHCP) Network Settings:** A section with a note about static settings. It has four empty text boxes for 'IP address', 'Network mask', 'DNS server 1', and 'DNS server 2'.

- 1 The **Hostname** box will display Planar as the default. Change this name to something more appropriate for this particular server. The hostname is limited to 16 characters: alphanumeric, dash, or underscore only.
- 2 If you want to enter a domain name for server name lookups, type it in the **Domain name** box.
- 3 Do one of the following:
 - If you will use DHCP, go to step 4.
 - If you will **not** use DHCP, go to step 5.
- 4 Under the DHCP section, select the **Yes, use DHCP** radio button.
 - a Change the default DHCP timeout (ten seconds) only if instructed by your network administrator.
 - b You do not need to fill in anything under the Static (non-DHCP) Network Settings section. However, if you do, these settings will be used in the event that the DHCP attempts to time out.
 - c Go to step 6.
- 5 Under the DHCP section, select the **No, use static settings** radio button.
 - a In the Static (non-DHCP) Network Settings section, enter the **IP address** provided by your Network Administrator.
 - b Enter the **Network mask, DNS server(s), and Gateway** as instructed by the network administrator.

- c Go to step 6.
 - 6 Scroll to the bottom of the page and click **Confirm and apply new network settings** to receive the Confirm Network Change page.
 - 7 Review the settings to make sure they are correct. Click **OK, apply changes now** to receive the Applying Network Changes page. This shows the network settings that will be used.
- Note:** If you have changed the static IP address or changed from static to DHCP setup, you may need to point your browser at the new address.
- 8 You may have to click the **Refresh** button on your browser to see the new name in the upper left corner of the page.

Remote Monitoring Date and Time

Use this page to change date and time information as needed.

The screenshot shows the 'Date and Time' configuration page for a Planar device. The page is divided into several sections:

- Date and Time:** A general section with explanatory text about NTP servers and time zones.
- Date and Time Server:** A section with input fields for 'NTP server name or address' (containing 'time.nist.gov') and 'Poll interval in minutes' (containing '5'). Below these fields are buttons for 'Apply Changes', 'Click here to apply server and interval settings changed above', and 'Apply new date and time server settings'.
- Manual Date and Time:** A section with a text box for 'Enter local time and date as HH:MM N:mm YYYY (12 digits required, use 24-hour clock)'. The text box contains '09/12 12:12 2014'. Below the text box is a 'Set date and time' button.
- Local Time Zone:** A section with detailed instructions on how to format the time zone string. It includes a 'Set time zone' button.

- 1 Set the date and time manually in the box under the Manual Date and Time section. The date format is very exact. Fill in the current date and time using exactly the format shown on the page. Click **Set date and time**.
- 2 If you want to have the server periodically check the time from a network source, fill in the NTP server name or address, and poll interval in the Date and Time Server section. Click **Apply new date and time server settings**.

Note: If you don't have a preferred NTP server, then **pool.ntp.org** is a good choice for most installations.

- 3 Carefully read the instructions in the Local Time Zone section. Fill in the text box and click **Set time zone**.

Note: The start and end of daylight saving time default to the first Sunday of April and the last Sunday of October. As of 2007, U.S. locales that observe daylight saving time must enter start and end dates in this section. For example, EST5EDT,M3.2.0,M11.1.0 is correct for U.S. Eastern time zone as of 2007.

Remote Monitoring Access Control

The Access Control page allows you to set parameters needed to access the web, the Remote Monitoring network and RS232 commands. It also allows you to select the correct baud rate.

The screenshot shows the 'Access Control' page for a Planar device (planar-0080a3917cf9). The page is divided into three main sections:

- Web Access:** Contains a note about password protection and three password fields: 'View password', 'Operator password', and 'Admin password'. Each field has a 'Confirm' field and a 'Set' button.
- Network Access:** Contains a note about daytime service and several checkboxes:
 - Enable daytime service (UDP port 13)
 - Enable ASCII command service (UDP port 37)
 - Enable telnet login
 - Enable SNMP
 Below these are input fields for 'Read only Community String' (value: public) and 'Read Write Community String' (value: private). A 'Change network access' button is at the bottom.
- Reboot:** Shows the current time as 'Fri 12 Sep 2014 12:12:45 PDT'.

Remote Monitoring Software Setup (Upgrading Network Firmware)

This page allows you to upload the latest UltraRes Remote Monitoring software. You can also reset all of your settings to the factory defaults, as well as choose the web page link that is associated with the Planar logo in the top right corner of the page.

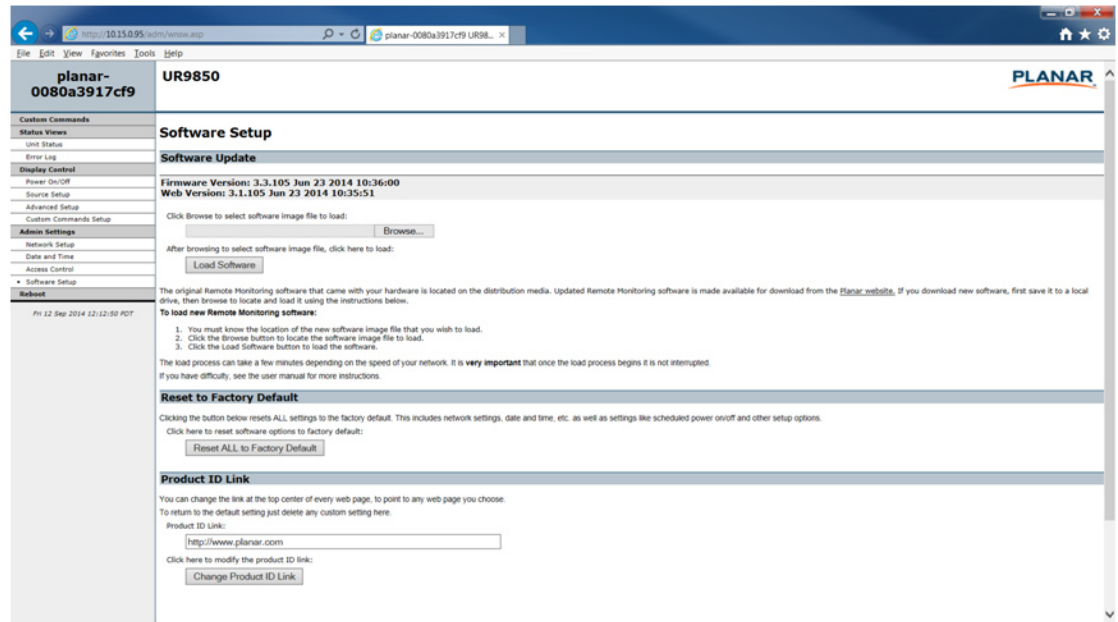

- 1 Click **Choose File** to locate the latest UltraRes software that you downloaded from Planar's website.

Note: Make sure the software is downloaded to a local drive.

- 2 Click **Load Software** to load the new software. This process can take a few minutes, depending on the speed of your network. It is **very important** that you do not interrupt the load process once it begins!
- 3 If you want to reset **ALL** settings to the factory default, click **Reset ALL to Factory Default**. This includes network settings, date and time, etc., as well as display settings.

Caution: Using this option will reset all of your configurations and reboot the remote monitor. Because this includes network settings, be aware that the UltraRes Remote Monitoring software may not configure to the same network address after the system reboots.

- 4 When you click **Reset ALL to Factory Default**, you receive the Confirm Factory Reset page. Click **OK, Reset to Factory Defaults and Reboot** if you are sure you want to reset ALL settings to the factory default.
- 5 The top of each page shows the Planar logo, which is a link to <http://www.planar.com>. You can change this link to refer to any URL that you find useful by typing it into the **Product ID Link** box.

- 6 To make this link live, click **Change Product ID Link**.
- 7 In normal operations, Remote Monitoring polls the displays at a rate of one per second to look for user requests that have been made using the IR remote control and the on-screen menus. In some situations, this polling can have a noticeable performance impact. If you want to disable this polling, select the **Disable polling for alert conditions** checkbox. When you are finished, click **Change Advanced Settings**.

Remote Monitoring Reboot

Click **Reboot now** to reboot your system. The reboot takes about 90 seconds.

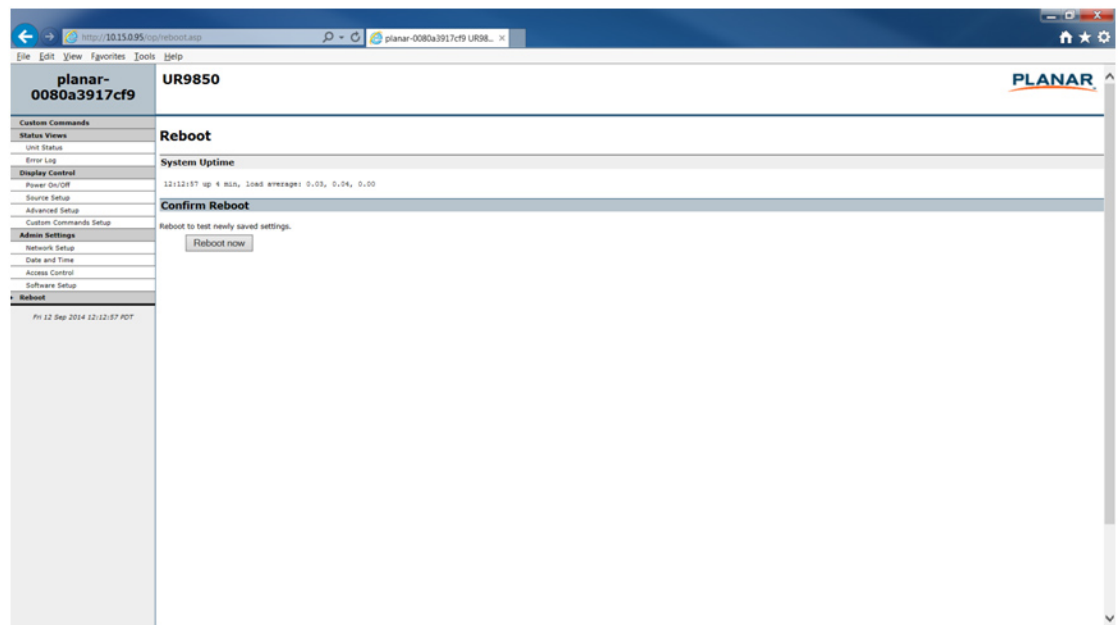

External Control

In addition to using the UltraRes remote control and display, there are other methods of controlling the UltraRes externally:

- Using a serial (RS232) link to send ASCII commands and to receive responses to those commands.
- Using discrete infrared (IR) codes to program a third-party remote control.
- Using SNMP (Simple Network Management Protocol) controls using web browser settings.

RS232 Communication

RS232 control is not necessary for operation, but is a convenient way to control displays from a computer at a distance. If your installation will not use RS232 control, you can skip this section. Most things you can do with the remote, you can do with RS232 commands. Plus, you can send inquiries to the displays and find out the current settings and values. RS232 connections are made with standard straight-through cables.

Connecting the RS232 Cable

The RS232 cable will connect to a PC or control system, depending on your setup.

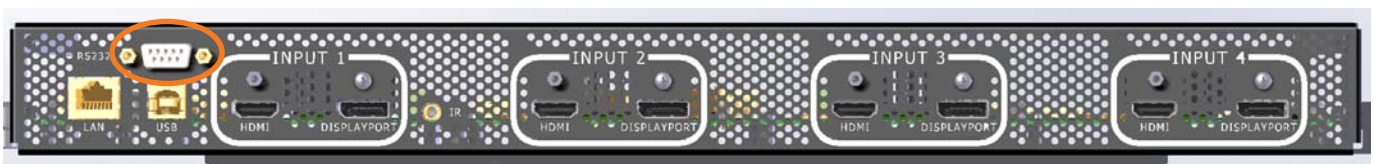

Setting Up Multiple Inputs Using RS232 Commands

You can also set up multiple inputs using RS232 commands. As is typical with using RS232 commands, you can pull up a basic program such as Tera Term to send commands. Below is a short example.

```
COM8:19200baud - Tera Term VT
File Edit Setup Control Window Help
<ins=0>
<0;INS=0>
<inn=2>
<0;INM=2>
<mi1=2>
<0;MI1=2>
<mi2=1>
<0;MI2=1>
<mi3=2>
<0;MI3=2>
<mi4=1>
<0;MI4=1>
```

Setting Up Single Inputs Using RS232 Commands

You can set up single inputs using RS232 commands. As is typical with using RS232 commands, you can pull up a basic program such as Tera Term to send commands. Below is a short example.

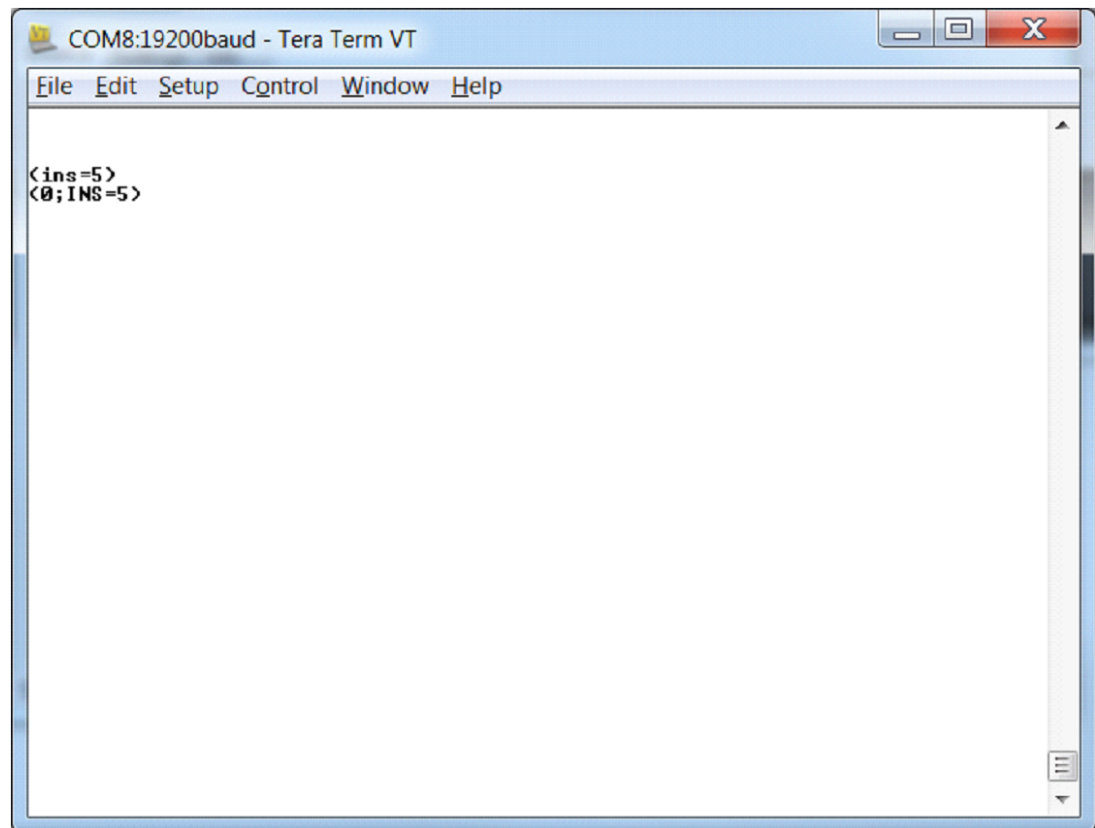

RS232 Commands

The RS232 connection must use the following settings:

- 19200 baud rate
- 8 data bits
- 1 stop bit
- No parity bit
- No HW (RTS/CTS) or SW (XON/XOFF) flow control

RS232 Command Format

Commands sent from the initiator to the follower must have the following format:

(www : xyz) [CR]

Where:

- ‘(’ and ‘)’ indicate the start and end of the command data. If these characters are present, the display processor shall assume that “valid” display data is present in the command string. If these characters are not present in the command, the display processor shall assume the data is not valid display data and ignore it.
- “www” indicates the command code. This field is case insensitive (i.e. “PWR”, “pwr” and “PwR” should all be treated as “PWR”).
- “:x” is the destination parameter. This is an optional parameter that indicates which memory the command is referencing. This parameter is reserved and shall not be used at this time.
- “y” is the operand, which can have one of the following values:
 - ‘?’ = “Get” operand
 - ‘=’ = “Set” operand
 - ‘+’ = “Increment” operand (not supported on UltraRes)
 - ‘-’ = “Decrement” operand (not supported on UltraRes)
- “z” is the value to set for this parameter. It can have one of two formats:
 - Integer value: Any positive or negative number (example: 100)
 - String value: Any string surrounded by double quotes (example: “This is a string”)
- “[CR]” is the ASCII carriage return key (0x0D).

RS232 Response Format

Responses sent from the follower to the initiator shall have the following format:

$$(u ; www : x = z) [CR]$$

Where:

- ‘(’ and ‘)’ indicate the start and end of the command data. If these characters are present, the display processor shall assume that “valid” display data is present in the command string. If these characters are not present in the command, the display processor shall assume the data is not valid display data and ignore it.
- “u;” indicates the response code. This is only used by followers responding to a valid display command received. For any response code other than 0, the follower shall echo back the command received rather than filling in the fields listed below. The following response codes can be used:
 - 0 = Command successfully processed
 - 1 = Unknown command code
 - 2 = Invalid operator
 - 3 = Destination parameter not supported
 - 4 = Setting not available
 - 5 = Setting value not available
 - 6 = Setting value not supported
 - 7 = String too long
 - 8 = Command not supported in standby mode
 - 9 = Invalid parameter
 - 10 = Error processing command
 - 11 = Password not entered
- “www” indicates the command code sent by the follower. This field is case insensitive (i.e. “PWR”, “pwr” and “PwR” should all be treated as “PWR”).
- “:x” is the destination parameter. This is an optional parameter that indicates which memory the response is referencing. This parameter is reserved and shall not be used at this time.
- “z” is the new value (for set/increment/decrement commands) or the current value (for get commands) for this parameter. It can have one of two formats:
 - Integer value: Any positive or negative number (example: 100)
 - String value: Any string surrounded by double quotes (example: “This is a string”)
- “[CR]” is the ASCII carriage return key (0x0D).

RS232 Command/Response Examples

The following section gives examples of commands and their responses:

Example: Power query when unit is powered on

Command: (PWR?) [CR]

Response: (0;PWR=1) [CR]

Example: Set power to 0 (off)

Command: (PWR=0) [CR]

Response: (0;PWR=0) [CR]

Example: Increment brightness from 24 to 25

Command: (BRT+) [CR]

Response: (0;BRT=25) [CR]

Example: Invalid command code

Command: (ZZZ=0) [CR]

Response: (1;ZZZ=0) [CR]

Example: Invalid parameter (string instead of int)

Command: (CON="Some string") [CR]

Response: (9;CON="Some string") [CR]

Supported UltraRes RS232 Commands

The following section lists the commands that are currently support on the UltraRes display.

Setting	Command Code	Read/Write	Inc/Dec	Min Value	Max Value	String?	Password Protected?	Notes
Auto Power Off Enable	APE	R/W	No	0	1	No	No	0 = Off 1 = On
Auto Power Off Timer	APT	R/W	No	1	60	No	No	Value is in minutes
Backlight	BKL	R/W	No	1	15	No	No	
Brightness	BRT	R/W	No	0	100	No	No	
Blank Screen Blue	BSB	R/W	No	0	255	No	No	
Blank Screen Green	BSG	R/W	No	0	255	No	No	
Blank Screen Red	BSR	R/W	No	0	255	No	No	
Color Space	CLS	R/W	No	0	4	No	No	0 = REC601 1 = REC709 2 = RGB 3 = RGB Video 4 = Auto
Contrast	CON	R/W	No	0	100	No	No	
Color Temp Simple	CTS	R/W	No	0	4	No	No	0 = 3200K 1 = 5500K 2 = 6500K 3 = 7500K 4 = Native
Display Blue Gain	DBG	R/W	No	0	200	No	No	
Display Blue Offset	DBO	R/W	No	0	200	No	No	
Display Green Gain	DGG	R/W	No	0	200	No	No	

Setting	Command Code	Read/Write	Inc/Dec	Min Value	Max Value	String?	Password Protected?	Notes
Display Green Offset	DGO	R/W	No	0	200	No	No	
Display Red Gain	DRG	R/W	No	0	200	No	No	
Display Red Offset	DRO	R/W	No	0	200	No	No	
EDID Type	EDT	R/W	No	0	1	No	No	0 = 4K 30Hz Preferred EDID 1 = 1080p Preferred EDID 2 = 960x2160 Preferred EDID 3 = 1920x2160 Preferred EDID 4 = 4K 60Hz Preferred EDID
Error Log 1	EL1	R	No	N/A	N/A	Yes	No	Response contains 50 hex digits representing the first 25 entries in the error log
Error Log 2	EL2	R	No	N/A	N/A	Yes	No	Response contains 50 hex digits representing the second 25 entries in the error log
Error Code	ERR	R	No	0	TBD	No	No	0 = None 1 = AC Power Supply 1 Failure 2 = AC Power Supply 2 Failure 3 = AC Power Supplies 1 and 2 Failure 8 = AC Power Status Cable Disconnected 9 = DC Power Supply Failure 10 = FPGA Initialization Failure 11 = Calibration EEPROM Failure 12 = Overtemp
Bottom Frame Delay	FDB	R/W	No	0	2	No	No	
Top Frame Delay	FDT	R/W	No	0	2	No	No	
Firmware Upgrade	FWU	W	No	N/A	N/A	No	No	Action will be performed on any setting value
Gamma Simple	GMS	R/W	No	0	6	No	No	0 = 2.0 1 = 1.8 2 = 2.2 3 = 2.35 4 = 2.5

Setting	Command Code	Read/Write	Inc/Dec	Min Value	Max Value	String?	Password Protected?	Notes
Information Boot Version	IBV	R	No	N/A	N/A	Yes	No	
Information Current Color Space	ICC	R	No	0	3	No	No	0 = REC601 1 = REC709 2 = RGB 3 = RGB Video
Information FPGA 1 Version	IF1	R	No	N/A	N/A	Yes	No	
Information FPGA 2 Version	IF2	R	No	N/A	N/A	Yes	No	
Information FPGA 3 Version	IF3	R	No	N/A	N/A	Yes	No	
Information FPGA 4 Version	IF4	R	No	N/A	N/A	Yes	No	
Information Firmware Version	IFV	R	No	N/A	N/A	Yes	No	
Input Mode	INM	R/W	No	0	2	No	No	0 = Single Input 2 = Multiple Inputs
Input Source	INS	R/W	No	0	15	No	No	0 = DisplayPort 1 1 = DisplayPort 2 2 = DisplayPort 3 3 = DisplayPort 4 4 = HDMI 1 5 = HDMI 2 6 = HDMI 3 7 = HDMI 4
IP Address	IPA	R	No	N/A	N/A	Yes	No	
Information Pixel Clock	IPC	R	No	N/A	N/A	Yes	No	
Information Signal Format	ISF	R	No	N/A	N/A	Yes	No	

Setting	Command Code	Read/Write	Inc/Dec	Min Value	Max Value	String?	Password Protected?	Notes
Information Serial Number	ISN	R	No	N/A	N/A	Yes	No	
Information Temperature Sensor	ITS	R	No	N/A	N/A	No	No	Value returned is in Celsius
Remote Key	KEY	W	No	0	92	No	No	1 = On 2 = Off 3 = Menu 4 = Enter 5 = Up 6 = Down 7 = Left 8 = Right 19 = HDMI 1 20 = HDMI 2 21 = HDMI 3 22 = HDMI 4 85 = DisplayPort 1 87 = DisplayPort 2 88 = DisplayPort 3 89 = DisplayPort 4 90 = Single Input 91 = Multiple Inputs 92 = Previous
Local Dimming	LDM	R/W	No	0	1	No	No	0 = Off 1 = On
Model Name	MDL	R	No	N/A	N/A	Yes	No	
Multiple Input 1	MI1	R/W	No	0	2	No	No	0 = Based on Input Source 1 = DisplayPort 1 2 = HDMI 1
Multiple Input 2	MI2	R/W	No	0	2	No	No	0 = Based on Input Source 1 = DisplayPort 2 2 = HDMI 2
Multiple Input 3	MI3	R/W	No	0	2	No	No	0 = Based on Input Source 1 = DisplayPort 3 2 = HDMI 3

Setting	Command Code	Read/Write	Inc/Dec	Min Value	Max Value	String?	Password Protected?	Notes
Multiple Input 4	MI4	R/W	No	0	2	No	No	0 = Based on Input Source 1 = DisplayPort 4 2 = HDMI 4
Multiple Input Preset Apply	PSA	W	No	0	7	No	No	Value = preset number
Multiple Input Preset Save	PSS	W	No	0	7	No	No	Value = preset number
Power	PWR	R/W	No	0	1	No	No	0 = Off 1 = On
Splash Enable	SPE	R/W	No	0	2	No	No	0 = Off 1 = Landscape 2 = Portrait
Source Setup All	SSA	R/W	No	N/A	N/A	Yes	No	String format = "aabbccddeeff", where: "aa" is the Input Source value, in hex. "bb" is the Input Mode value, in hex. "cc" is the Multiple Input 1 setting, in hex. "dd" is the Multiple Input 2 setting, in hex. "ee" is the Multiple Input 3 setting, in hex. "ff" is the Multiple Input 4 setting, in hex.
Status	STA	R	No	0	4	No	No	0 = Standby 1 = Powering Up 2 = On 3 = Powering Down 4 = Error
Standby Mode	STB	R/W	No	1	0	No	No	0 = Low Power 1 = Fast Startup
System Reset	SYS	W	No	N/A	N/A	No	No	Action will be performed on any setting value

SNMP Monitoring

The current settings and status of UltraRes units can be remotely monitored using SNMP (Simple Network Management Protocol), if the SNMP option is enabled through the web browser settings. The MIB (Management Information Base) used for all Planar display products is available by electronic distribution in the file PLANAR-DISPLAY-MIB.txt. The table below shows the objects that can be monitored – all Planar SNMP objects are read-only, and no traps are used. The default read-only community string for all Planar SNMP objects is “public”. Once the PLANAR-DISPLAY-MIB is loaded in your SNMP manager, you can walk all the available objects from the top-level object PlanarSystems(1.3.6.1.4.1.19125) or its sub-object PlanarDisplayProduct(1).

Most object values are integer type, except where noted. Generally, for integer types, the value -1 is returned if there is any internal system or communication error, and normal return values are zero or positive integers.

Object Name	Description	Value
plnrModel	Model name (string)	UltraRes
plnrSWPart	Part number (string) for the Remote Monitoring software	010-01412
plnrSN1	Serial number (string)	
plnrVersion1	SNMP agent version (string)	
plnrVersion2	Firmware version (string)	See RS232 code “IFV”
plnrVersion3-6	FPGA 1-4 version (string)	See RS232 code “IF1” through “IF4”
plnrDisplayStatus	General display status	0 = Error 1 = OK -1 = N/A
plnrPowerStatus	Power status information	0 = Power off or error 1 = OK -1 = N/A
plnrDisplayBacklight	Backlight value	1-15. See RS232 code “BKL”
plnrDisplayColorSpace	User-selected color space	0-4. See RS232 code “CLS”
plnrInputSelect	User-selected input source	0-7. See RS232 code “INS”
plnrInputStatus	Input source status	0 = source absent 1 = source present
plnrInputHResolution	Horizontal resolution	Pixels
plnrInputVResolution	Vertical resolution	Pixels
plnrInputVRefresh	Vertical refresh rate	Hz x 100
plnrInputPixelClock	Dot clock value	MHz x 100
plnrTemp1	Internal temperature sensor value	Degrees C. See RS232 code “ITS”

Sending RS232 Commands Via UDP

The UDP port 57 accepts the same command sets as RS232. It is convenient for IP control applications and can be tested with a UDP terminal program such as Hercules.

Note: Ensure that the **Enable ASCII command service (UDP port 57)** box is checked on the Access Control page of the Remote Monitor software (see "Remote Monitoring Access Control" on page 96).

Notice the following in the example below:

- The IP address is 10.15.0.64
- Port 57 is selected
- "285057523F290D" in the **Send** box is hex for "(PWR?)"

Note: Most UDP terminal programs won't automatically send the [CR] at the end of the command, so the hex command is used to do this manually.

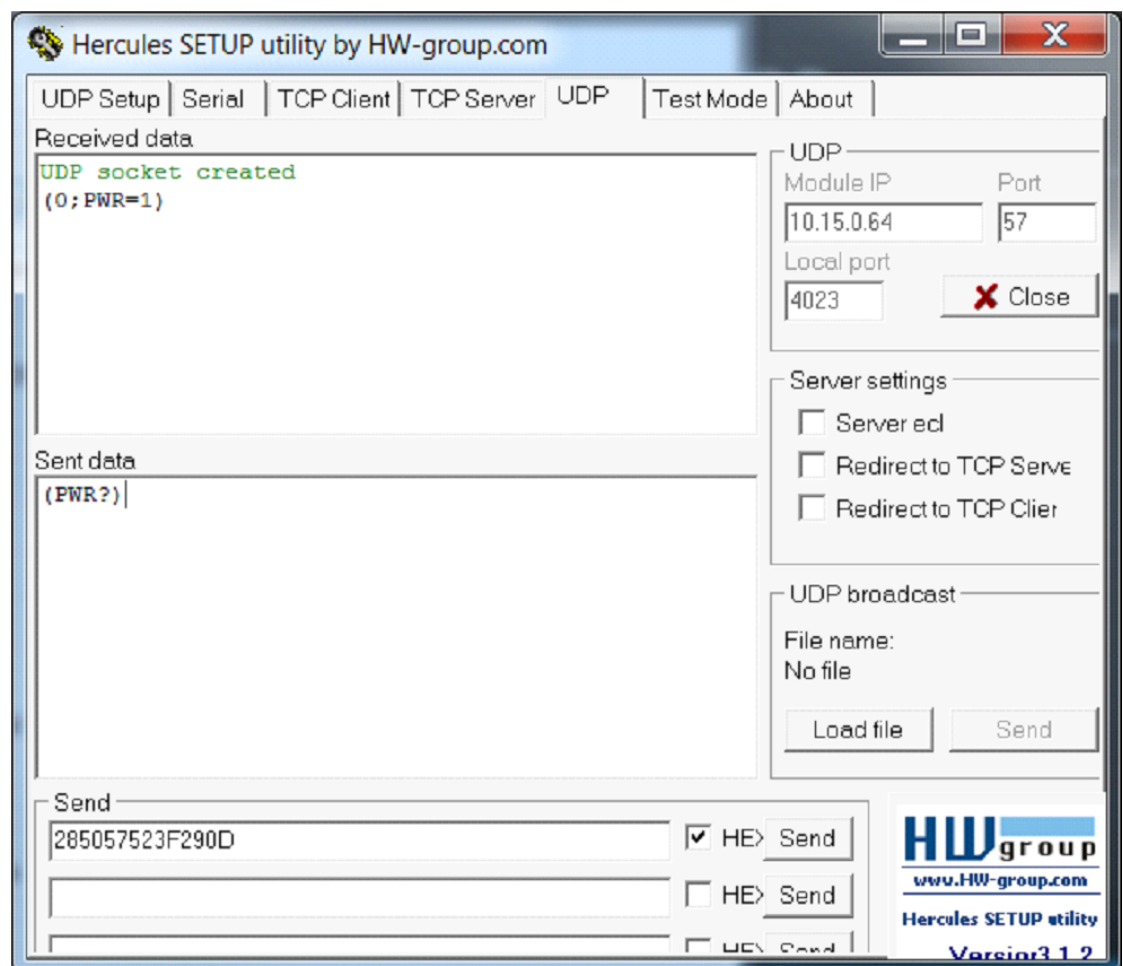

Using Discrete IR Codes

The UltraRes display accepts commands in the form of IR signals that conform to the NEC protocol. Each UltraRes remote control has an NEC control code associated with it. You can use these codes to program a third-party “universal” remote control to work with the UltraRes. These third-party products usually come with a computer software application for this purpose. For more information, consult the documentation provided with the remote control.

IR Command Protocol

The IR control codes have the following characteristics:

- Each code consists of the following:
 - A leader pulse (a modulated pulse of 9 ms followed by a non-modulated pulse of 4.5 ms)
 - 16 address bits. The default address is 1785 (0x06F9, binary 00000110 11111001)
 - 16 data bits: eight (8) bits for the command followed by the logical inverse of the command
 - An end pulse (a modulated pulse of 0.56 ms, similar to the modulated pulse in the ‘0’ and ‘1’ bits). The end of the modulated pulse constitutes the end of the data transmission.
- The carrier frequency is 38 kHz, with the modulated pulses having a 33% duty cycle.
- Commands are sent at a maximum rate of 9 Hz.

For example, below is the NEC control code for the ON button of the UltraRes remote control (assuming the default address is used).

Hex	06	F9	01	FE
Binary	00000110	11111001	00000001	11111110
Function	Address Byte 1	Address Byte 2	Command	Command (Logical Inverse)

The following example shows the pulse train for this command.



Supported UltraRes IR Commands

Remote Control Button Name	Address	Data	NEC Data From Remote
On	1785	1	0x06F901FE
HDMI 1	1785	2	0x06F902FD
DisplayPort 1	1785	3	0x06F903FC
HDMI 2	1785	6	0x06F906F9
DisplayPort 2	1785	7	0x06F907F8
Off	1785	9	0x06F909F6
HDMI 3	1785	10	0x06F90AF5
DisplayPort 3	1785	11	0x06F90BF4
Single Input	1785	13	0x06F90DF2
HMDI 4	1785	14	0x06F90EF1
DisplayPort 4	1785	15	0x06F90FF0
Multiple Inputs	1785	17	0x06F911EE
Menu	1785	21	0x06F915EA
Previous	1785	22	0x06F916E9
Enter	1785	23	0x06F917E8
Up	1785	26	0x06F91AE5
Left	1785	29	0x06F91DE2
Right	1785	31	0x06F91FE0
Down	1785	24	0x06F918E7

Touchscreen Setup

USB and Power Hook-Up

- 1 Plug in the 5V, 4A Power supply connector to the touchscreen power connector.

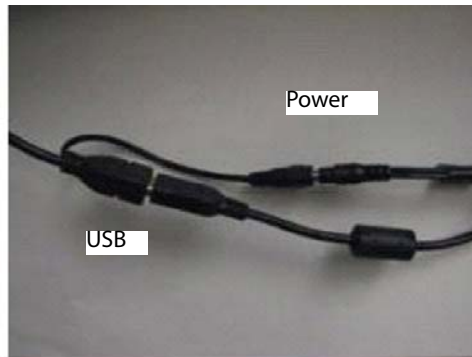

Note: USB and Power connection to the touchscreen.

- 2 Connect the 5V line cord to the power adapter.
- 3 Plug one end of the USB cable to the USB connector on the touchscreen and the other end to the PC.



Note: USB and Power connection to the touchscreen.

Touchscreen MultiTouch Driver Installation

- 1 With the PC on, plug in the USB memory stick to the USB drive.
- 2 Locate and open the USB drive.

- 3 Double-click on the “mt_driver_kitV4.1212RC2” to install the driver.
- 4 Follow installation prompts until driver installation is complete.

Once driver installation is complete, the touchscreen is ready for use.

Touchscreen (PQLabs) MultiTouch Platform Content

The PQLabs Software is used for troubleshooting and calibration. The different menus are described below.

- 1 On the PC, select the **Start** menu, **All Programs** and then **PQLabs Software**.
- 2 Click on “MultiTouch Platform” to open the PQLabs MultiTouch Platform window.

Touchscreen Information

- Serial Number – Displays the serial number of the connected touchscreen.
- Firmware Version – Displays the firmware version of the touchscreen selected under the “Serial Number” dropdown menu.
- Touch Points – Displays the number of touch points for which the touchscreen is capable.
- Status – Displays the current status of the touchscreen.

Calibration

- Calibration – Starts a 4-point calibration of the touchscreen. Perform the programmed touchscreen calibration process. At the conclusion of the calibration routine your touchscreen device is ready to use and will perform with accurately positioned touch points.
- Reset Calibration – Resets calibration to factory default settings.

Utility

- Diagnose – Starts the “MultiTouchDoctor” program. This can be used to troubleshoot issues with the touchscreen.

Options

- Default settings on options have the following programs enabled: Tuio Support, Flash Tuio Support, Handwriting Optimization, Enable Windows Native Touch, Enable Mouse/Keyboard Simulation, and Launch When Windows Starts Up.
- Flexible Scan Rate is at a default setting.

Uninstalling the MultiTouch Driver

- 1 On the PC, select the **Start** menu, **All Programs** and then **PQLabs Software**.

- 2 Click on the MultiTouch Driver.
- 3 Select the Uninstall option.

Specifications

LCD Module Specifications

Specification	UltraRes Display					
	Standard	ERO	Touch	Standard	ERO	Touch
Dimensions - 84"	inches			mm		
Width	75.5"	75.5"	75.8"	1918.7mm	1918.7mm	1924.3mm
Height	43.7"	43.7"	43.9"	1110.7mm	1110.7mm	1115.9mm
Diagonal overall	87.2"	87.2"	87.6"	2217mm	2217mm	2225mm
Depth - without mount	3.05"	3.05"	3.48"	77.5mm	77.5mm	88.5mm
Depth - with mount	3.17"	3.17"	3.60"	80.5mm	80.5mm	91.5mm
Dimensions - 98"	inches			mm		
Width	86.7"	86.7"	87.0"	2202.5mm	2202.5mm	2210.0mm
Height	49.5"	49.5"	49.8"	1257.5mm	1257.5mm	1265.0mm
Diagonal overall	99.9"	99.9"	100.3"	2536mm	2536mm	2546mm
Depth - without mount	3.60"	3.60"	3.95"	91.3mm	91.3mm	100.4mm
Depth - with mount	3.61"	3.61"	3.96"	91.6mm	91.6mm	100.7mm
Weight - 84"	lbs			kg		
LCD only	180lbs	200lbs	205lbs	82kg	91kg	93kg
Landscape mounts	32lbs			14.5kg		
Portrait mounts	20lbs			9kg		
Weight - 98"	lbs			kg		
LCD only	210lbs	295lbs	300lbs	95kg	134kg	136kg
Landscape mounts	40lbs			18kg		
Orientation - 84"	Landscape (LX, MX) or Portrait (MX version only)					
Orientation - 98"	Landscape					
Aspect ratio - 84"	16:9 (landscape) 9:16 (portrait)					
Aspect ratio - 98"	16:9 (landscape)					
LED life						
Minimum (half brightness)	30,000					
Typical (half brightness)	50,000					

LCD Optical Specifications

Specification	Maximum	Minimum	Typical
Screen brightness			
84" LX		280 cd/m ²	350 cd/m ²
84" MX		400 cd/m ²	500 cd/m ²
98" MX		400 cd/m ²	500 cd/m ²
Sequential contrast (local dimming enabled)			
84" LX			20,000:1
84" MX			20,000:1
98"			20,000:1
Sequential contrast (local dimming disabled)			
84" LX		1100:1	1600:1
84" MX		1000:1	1400:1
98"		900:1	1300:1
Uniformity			
84"		70%	
98"		75%	
Viewing Angle			
2D content		89° in all directions	
3D content left/right		89° in all directions	
3D content up/down		26° combined	30° combined
Color gamut			72% NTSC 100% REC709
84"			
Red (x,y)			0.645, 0.335
Green (x,y)			0.300, 0.620
Blue (x,y)			0.150, 0.060
White (x,y)			0.279, 0.292
98"			
Red (x,y)			0.654, 0.333
Green (x,y)			0.307, 0.602
Blue (x,y)			0.151, 0.063
White (x,y)			0.281, 0.288
Native color temperature			10,000K
Number of colors			1 billion
Native resolution			3840 x 2160

Environmental Specifications

Specification	Maximum	Minimum	Optimal	Notes
Temperature operating	40° C 104° F	0° C 32° F	20-25° C	All performance specifications are maintained within this temperature range.
non-operating	60° C 140° F	-20° C -4° F	20° C +/- 10° C	
Altitude (barometric pressure)	3000m			
Humidity operating	85% R.H.			non-condensing
non-operating	90% R.H.			non-condensing
Low line voltage range			100-120V	
High line voltage range			200-240V	
Line frequency range			49-61Hz	
Acoustic Noise				Fanless
Inrush current			60A	
Power consumption Standby			< 0.5W	
84" - Normal operation	550W		465W typ.	550W x 3.42 BTU = 1881 BTU/hr max. 465W x 3.42 BTU = 1590 BTU/hr typ.
98" - Normal operation	600W		520W typ.	600W x 3.42 BTU = 2052 BTU/hr max. 520W x 3.42 BTU = 1778 BTU/hr typ.

Signal Compatibility

The UltraRes display supports the following video modes.

Signal Type	Resolution	Frame Rate (Hz)	Line Rate (kHz)	Pixel Rate (MHz)	HDMI - RGB	HDMI - YUV	DisplayPort - RGB	DisplayPort - YUV	References
PC	640x480	60	31.469	25.175	✓		✓		VESA DMT, CEA-861-E Format 1
	960x2160	60	135	148.5	✓	✓	✓	✓	CEA-861-E, VIC 16, with horizontal parameters halved and vertical parameters doubled
	1920x2160	60	135	297	✓	✓	✓	✓	CEA-861-E, VIC 16, with vertical parameters doubled
	3840x2160	24	52.438	209.75	✓	✓	✓	✓	VESA CVT-R
	3840x2160	30	65.688	262.75	✓	✓	✓	✓	VESA CVT-R
EDTV	480p	60	31.469	27	✓	✓	✓	✓	ITU-R BT.1358, CEA-861-E Format 17 & 18
	576p	50	31.25	27	✓	✓	✓	✓	SMPTE 125M, CEA-861-E Format 6 & 7
HDTV	1080i	50	28.125	74.5	✓	✓	✓	✓	SMPTE 274M, CEA-861-E Format 20
	1080i	60	33.75	74.25	✓	✓	✓	✓	SMPTE 274M, CEA-861-E Format 5
	720p	50	37.5	74.25	✓	✓	✓	✓	SMPTE 296M, CEA-861-E Format 19
	720p	60	45	74.25	✓	✓	✓	✓	SMPTE 296M, CEA-861-E Format 4
	1080p	24	27	74.25	✓	✓	✓	✓	SMPTE 274M, CEA-861-E Format 32
	1080p	25	28.125	74.25	✓	✓	✓	✓	SMPTE 274M, CEA-861-E Format 33
	1080p	30	33.75	74.25	✓	✓	✓	✓	SMPTE 274M, CEA-861-E Format 34
	1080p	50	56.25	148.5	✓	✓	✓	✓	SMPTE 274M, CEA-861-E Format 31
	1080p	60	67.5	148.5	✓	✓	✓	✓	SMPTE 274M, CEA-861-E Format 16

UHDTV	3840x2160	24	54.000	297.000	✓	✓	✓	✓	SMPTE ST 2036-1:2009, HDMI 1.4b VIC 1
	3840x2160	25	56.250	297.000	✓	✓	✓	✓	SMPTE ST 2036-1:2009, HDMI 1.4b VIC 2
	3840x2160	30	67.500	297.000	✓	✓	✓	✓	SMPTE ST 2036-1:2009, HDMI 1.4b VIC 3
	3840x2160 (4:2:0)	50	56.250	297.000		✓			SMPTE ST 2036-1:2009, CEA-861-F Format 96
	3840x2160 (4:2:0)	60	67.500	297.000		✓			SMPTE ST 2036-1:2009, CEA-861-F Format 97

UltraRes Dimensions

84" Display Dimensions - Front, Side and Top Views

[dimension in inches]
dimension in mm

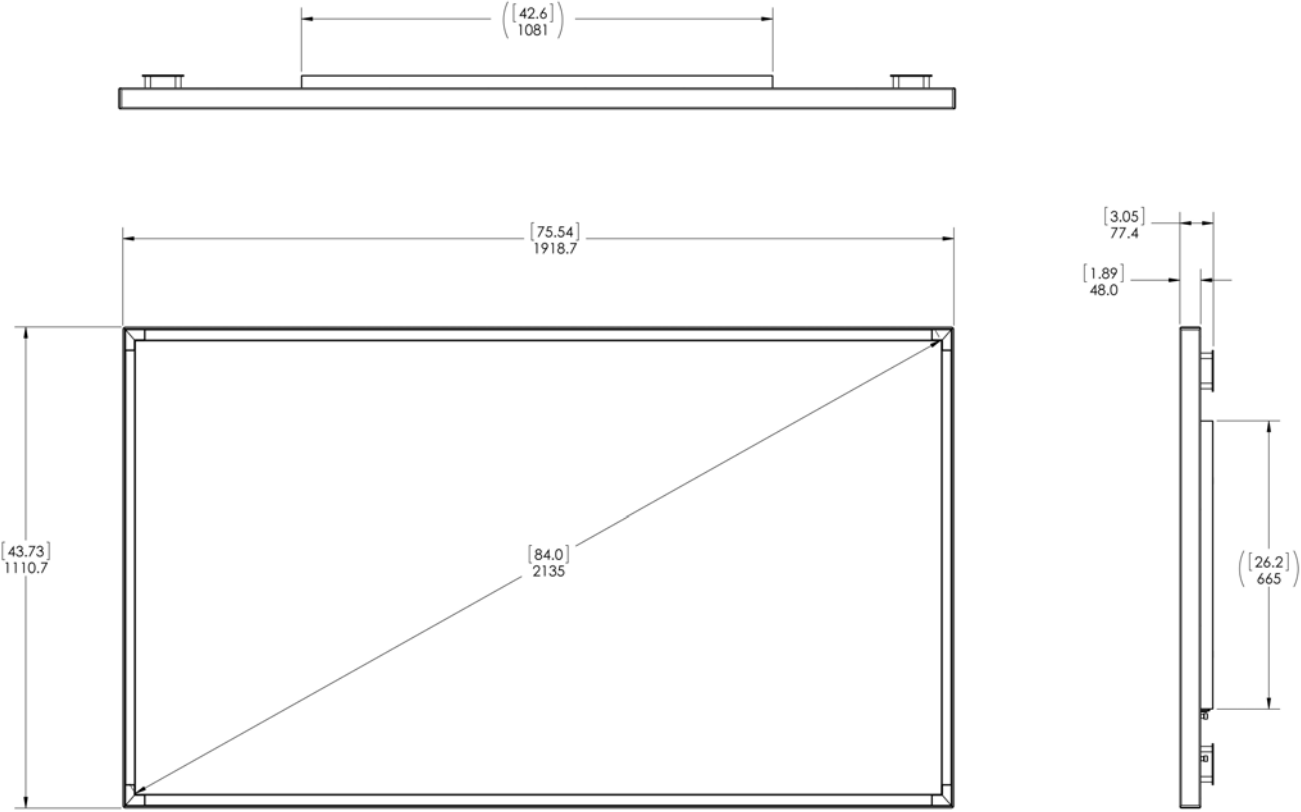

84" Display Dimensions - Rear View

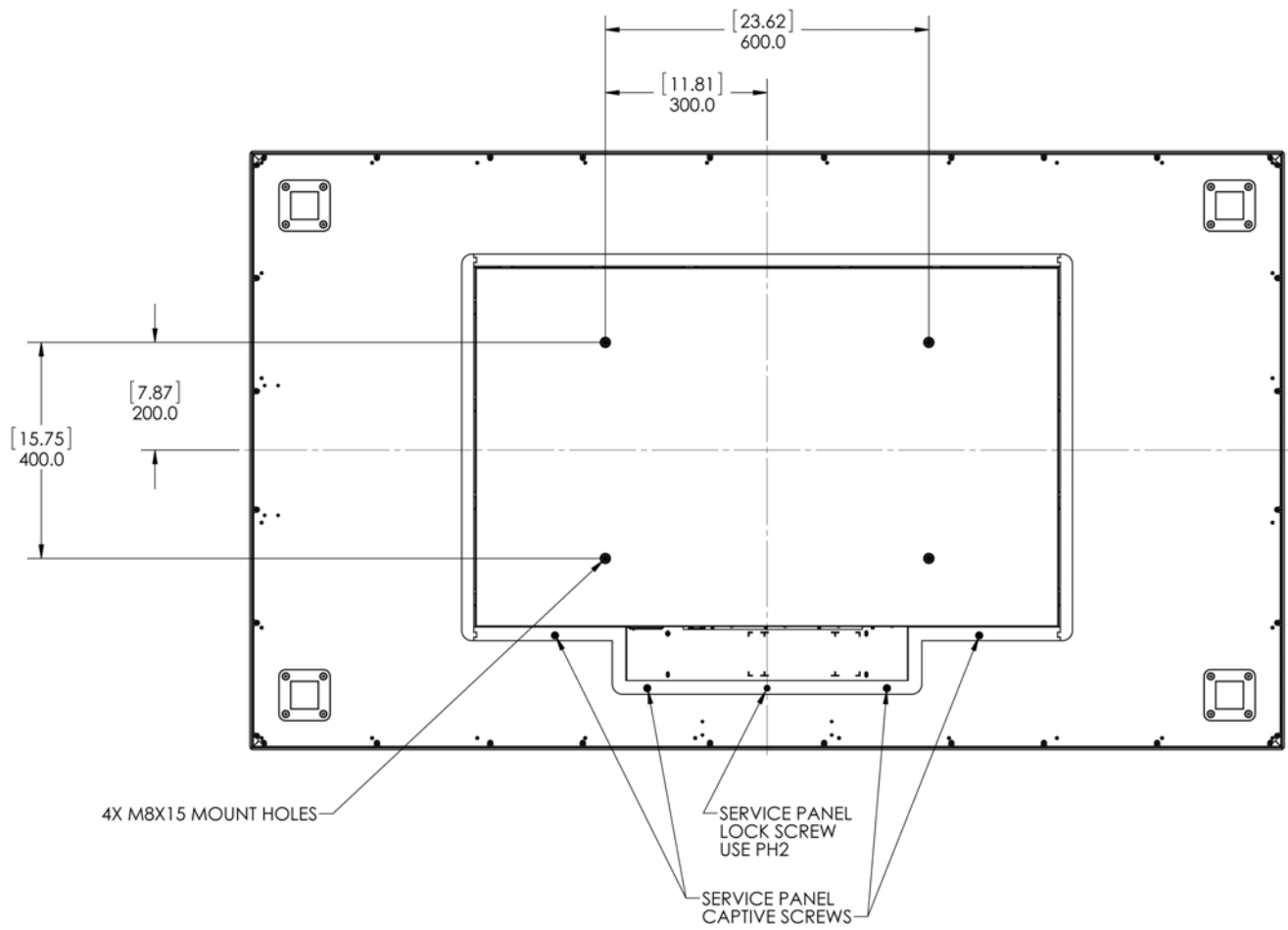

84" Rear View - Wall Mount Hangers and Service Panel Locations

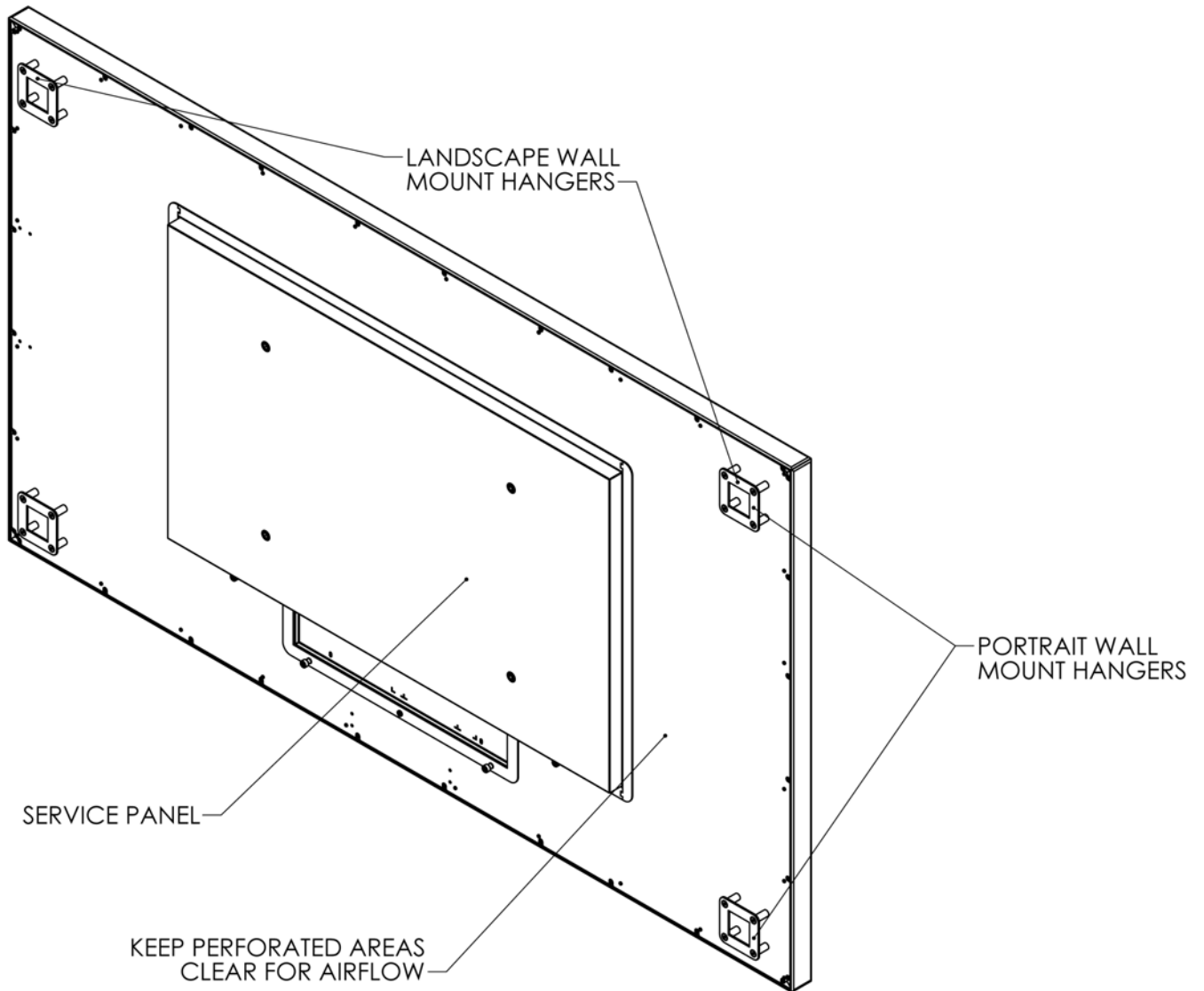

84" Landscape Wall Mounts - Front and Bottom Views

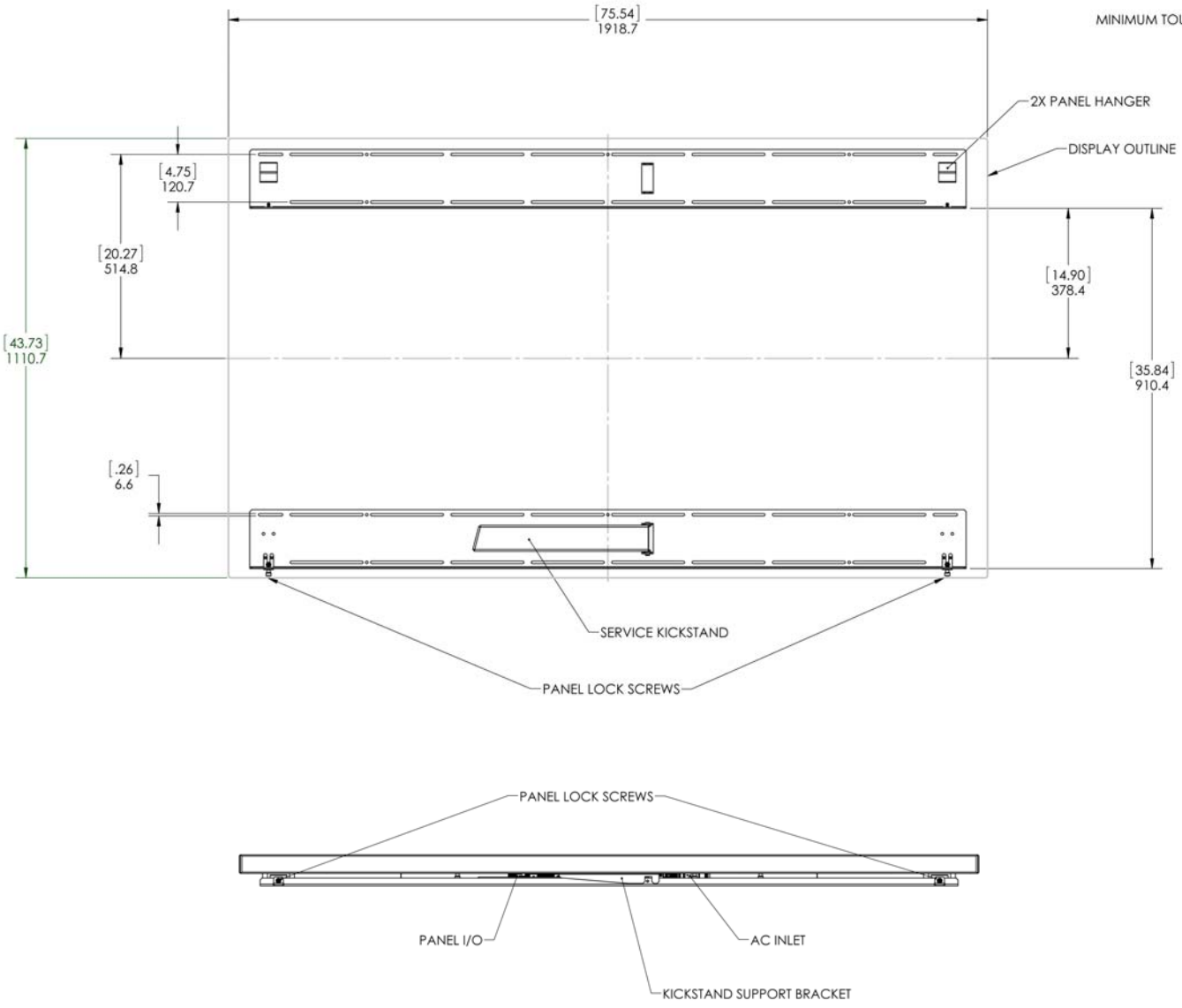

Note: Shown from the bottom of the panel.

84" Landscape Wall Mounts - Sides Views

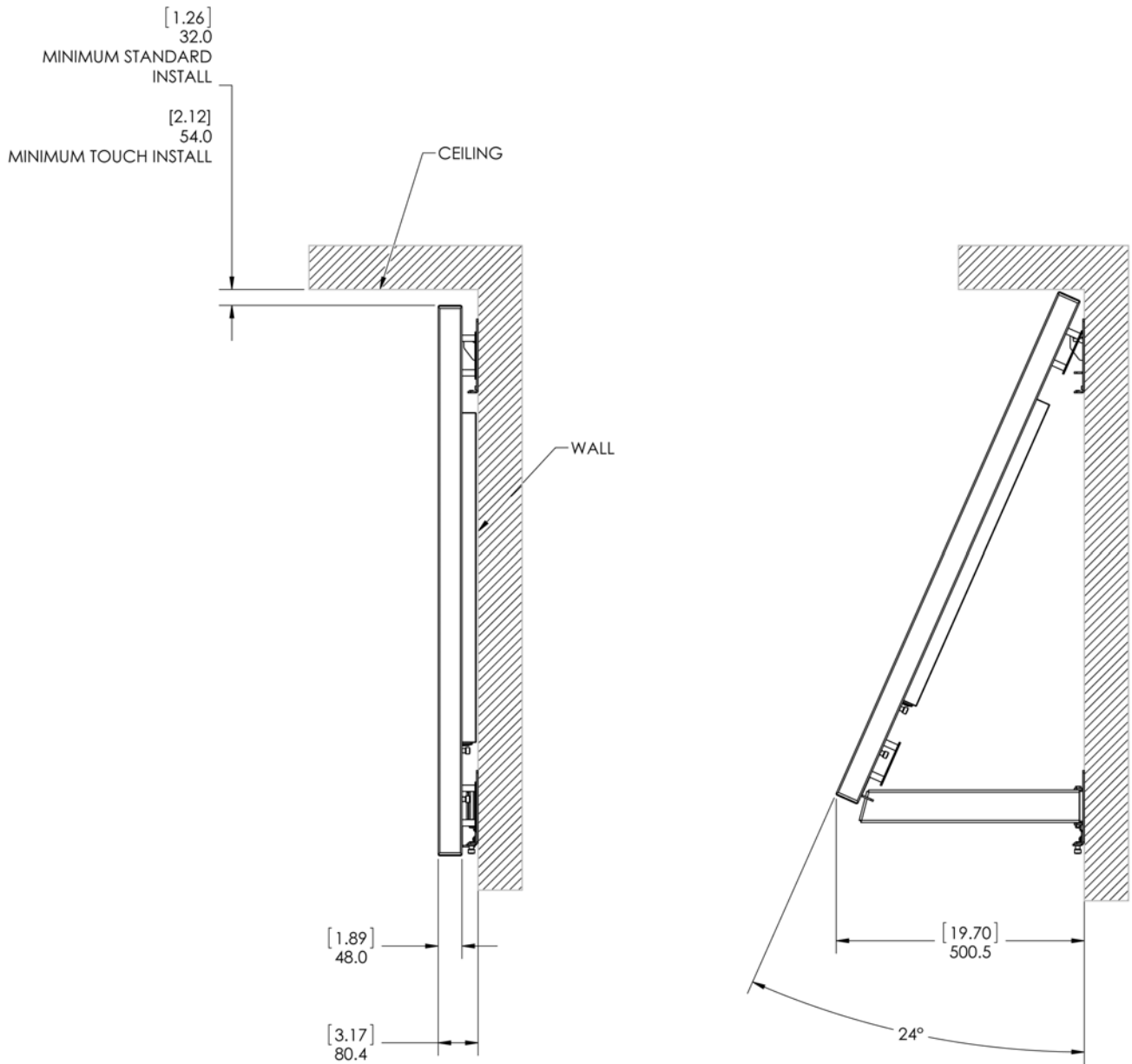

84" Portrait Wall Mounts - Front View

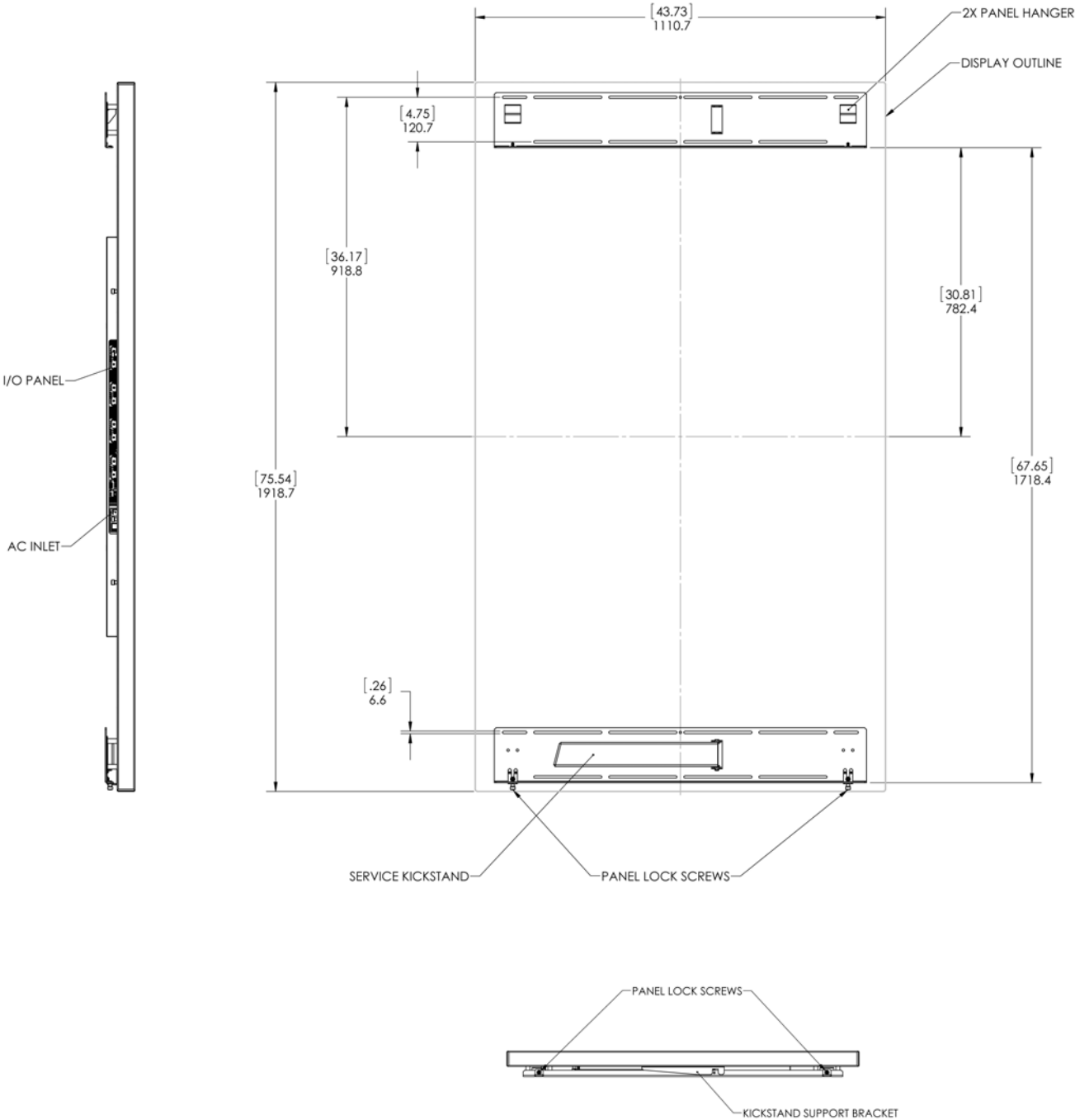

Note: Shown from the bottom of the panel.

84" Portrait Wall Mounts - Sides Views

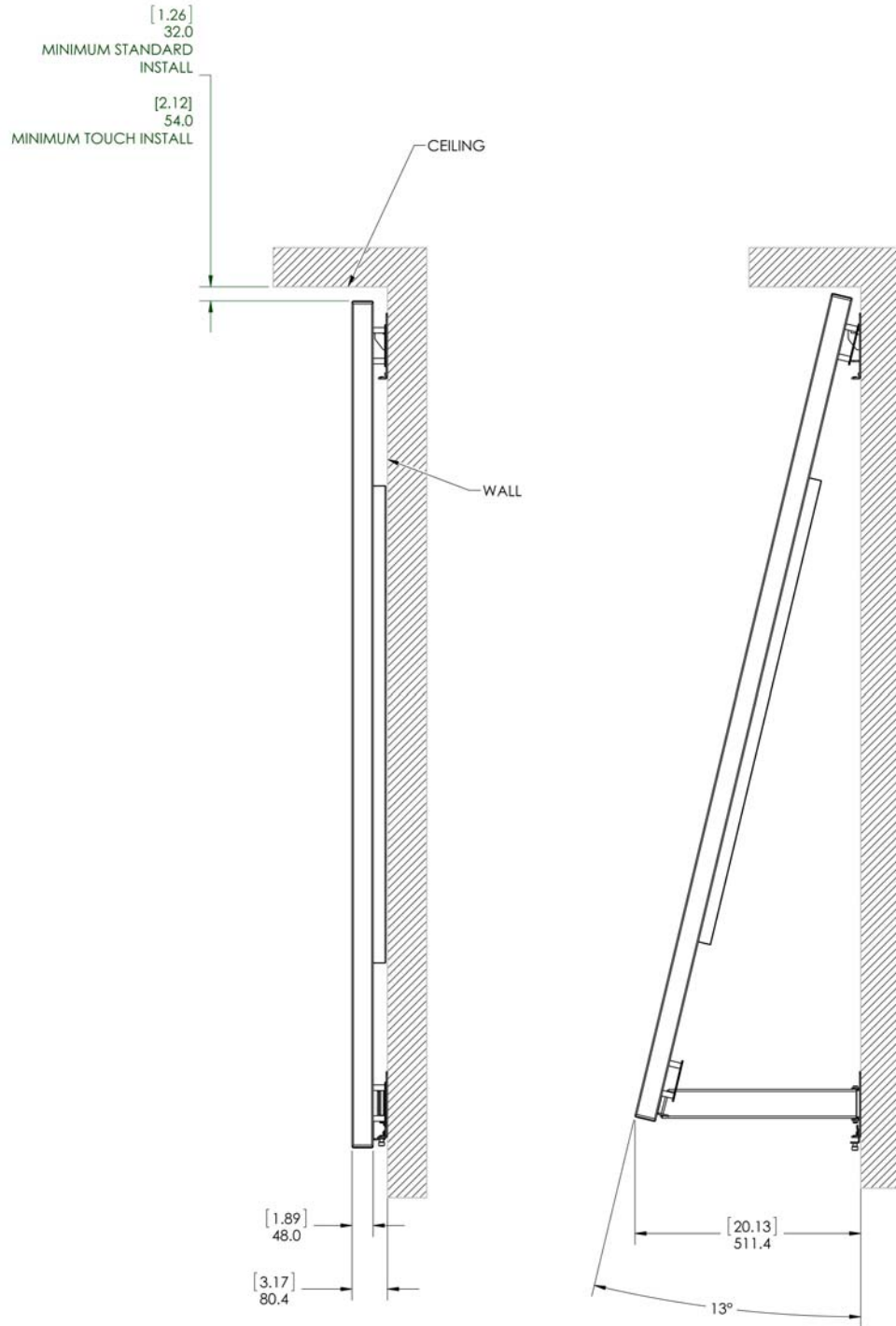

84" UltraRes Touch - Front, Top and Bottom Views

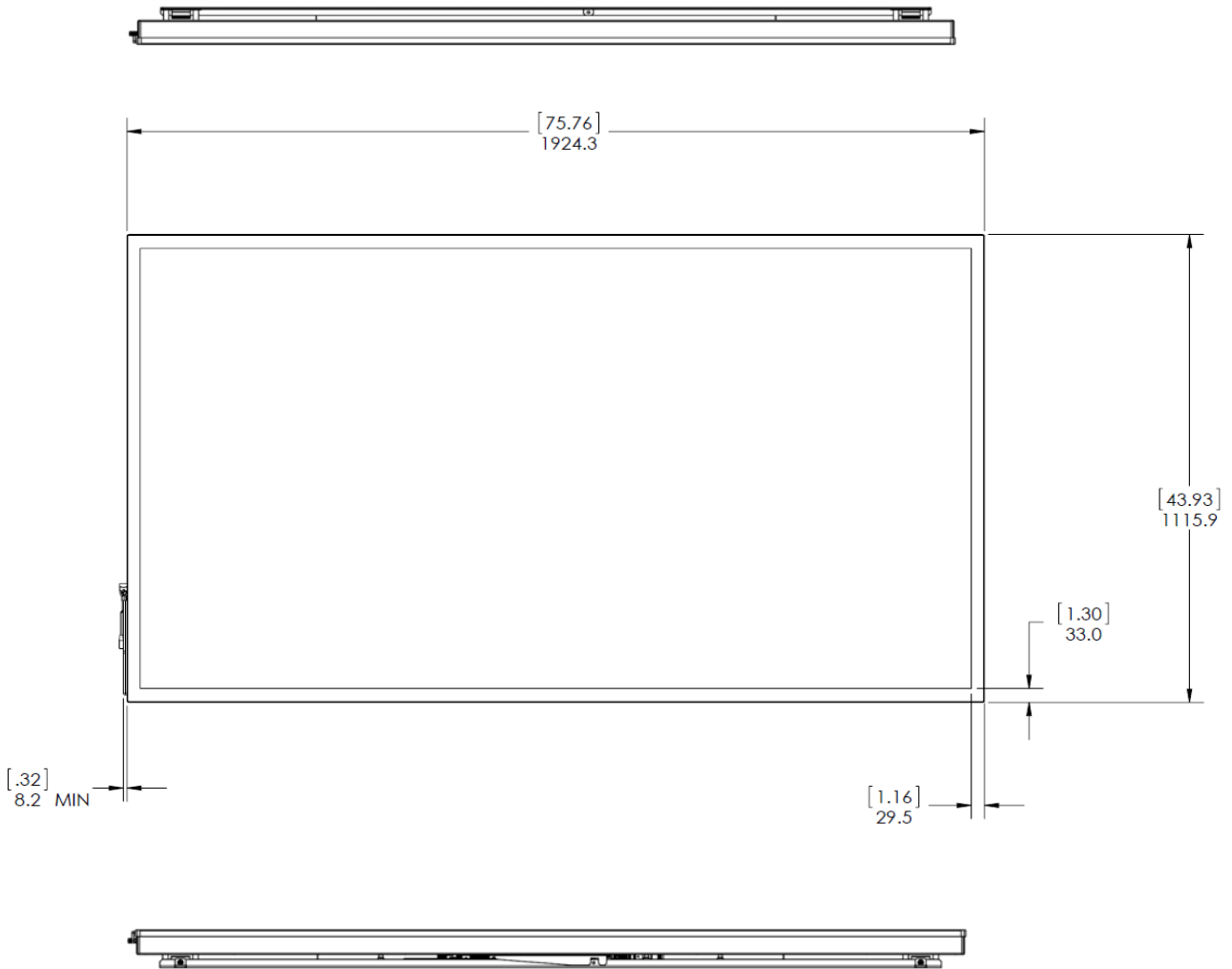

84" UltraRes Touch - Side Views

WITH MOUNT

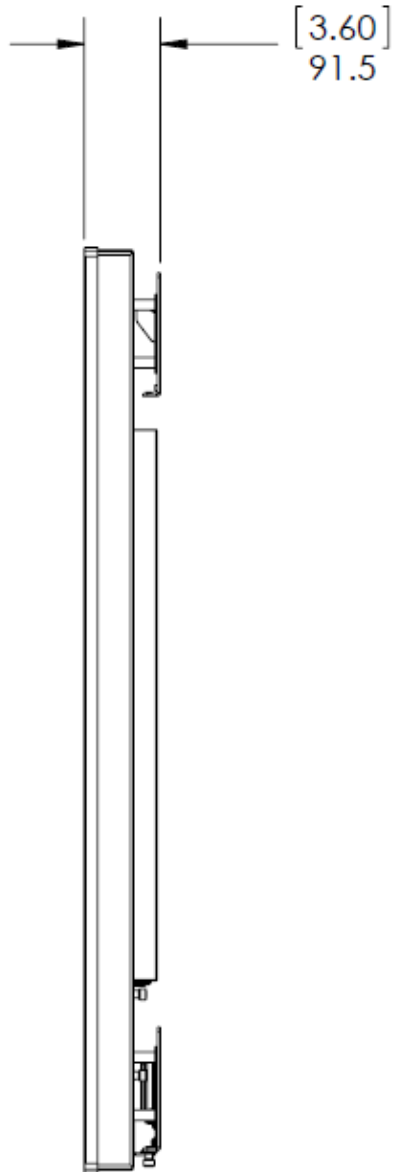

WITHOUT MOUNT

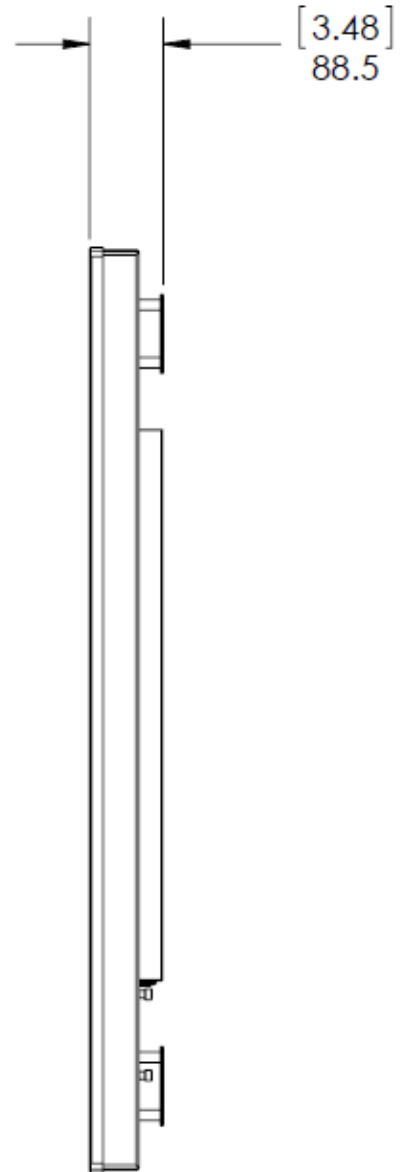

84" UltraRes Touch - Rear View

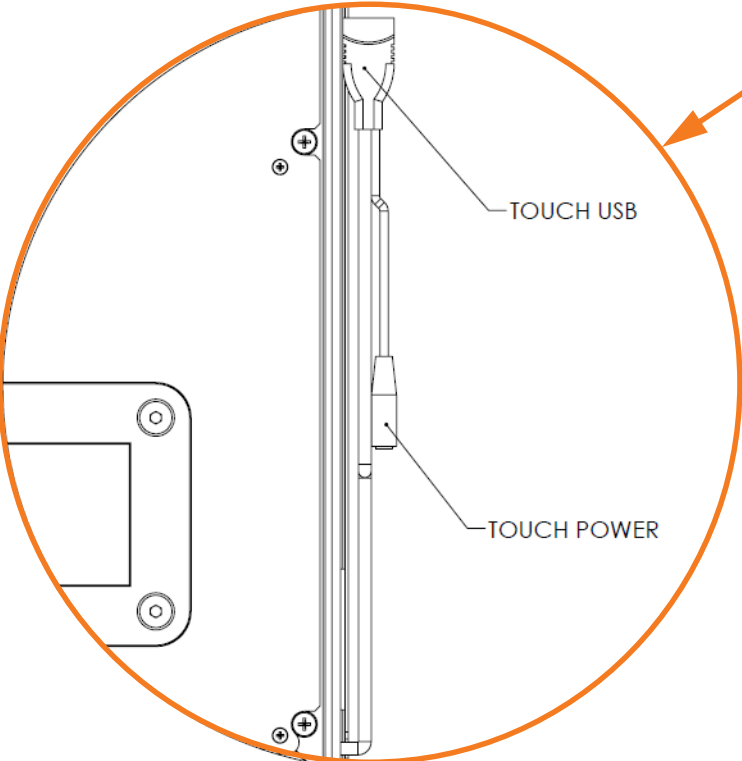
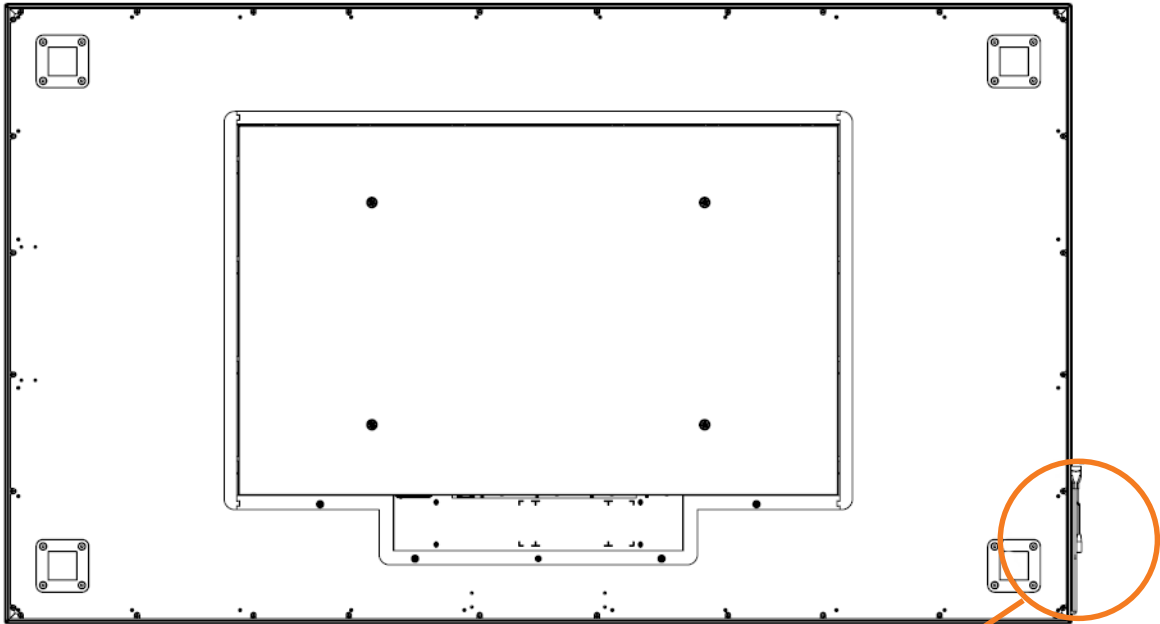

98" Display Dimensions - Front, Side and Top Views

[dimension in inches]
dimension in mm

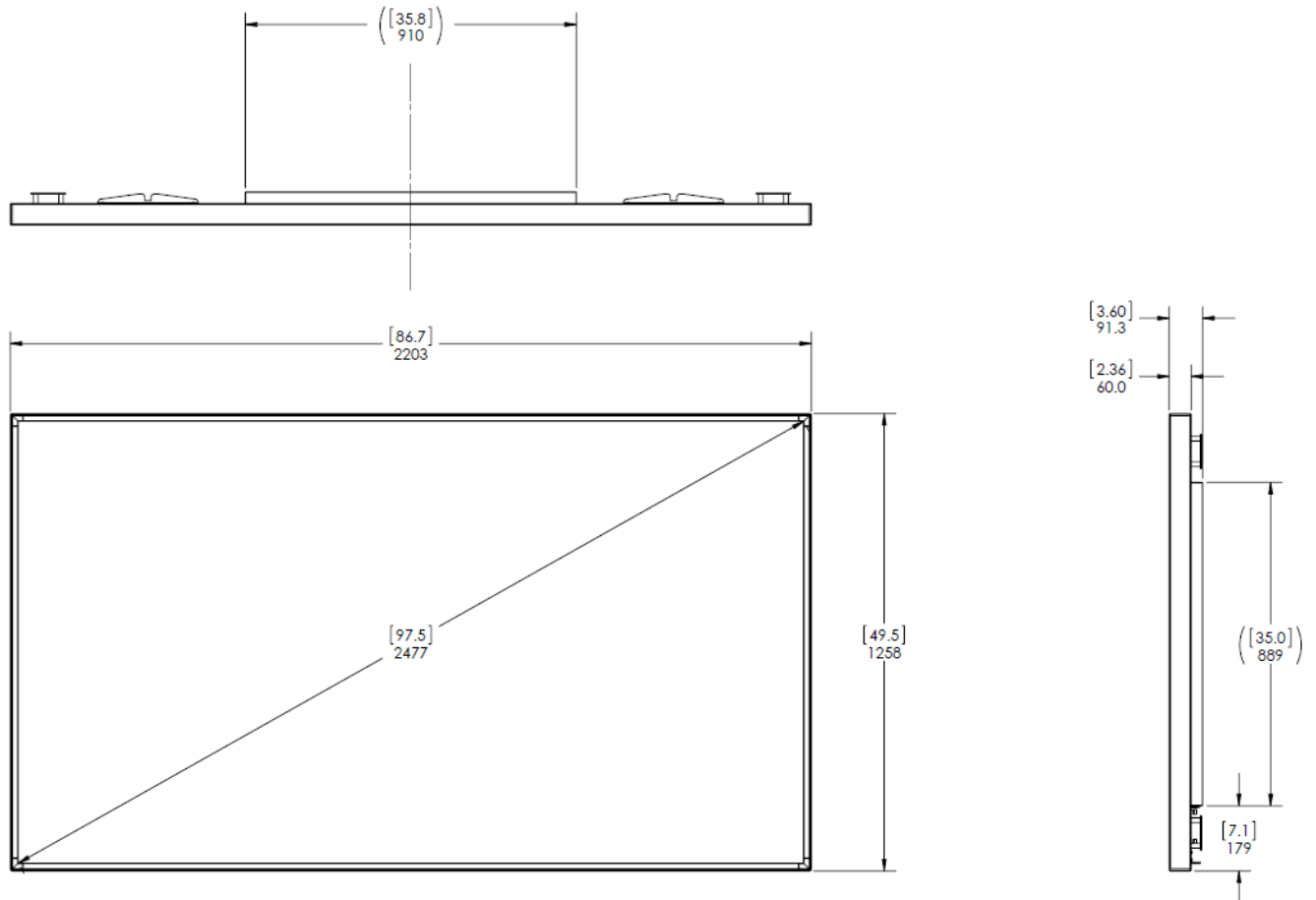

98" Display Dimensions - Rear View

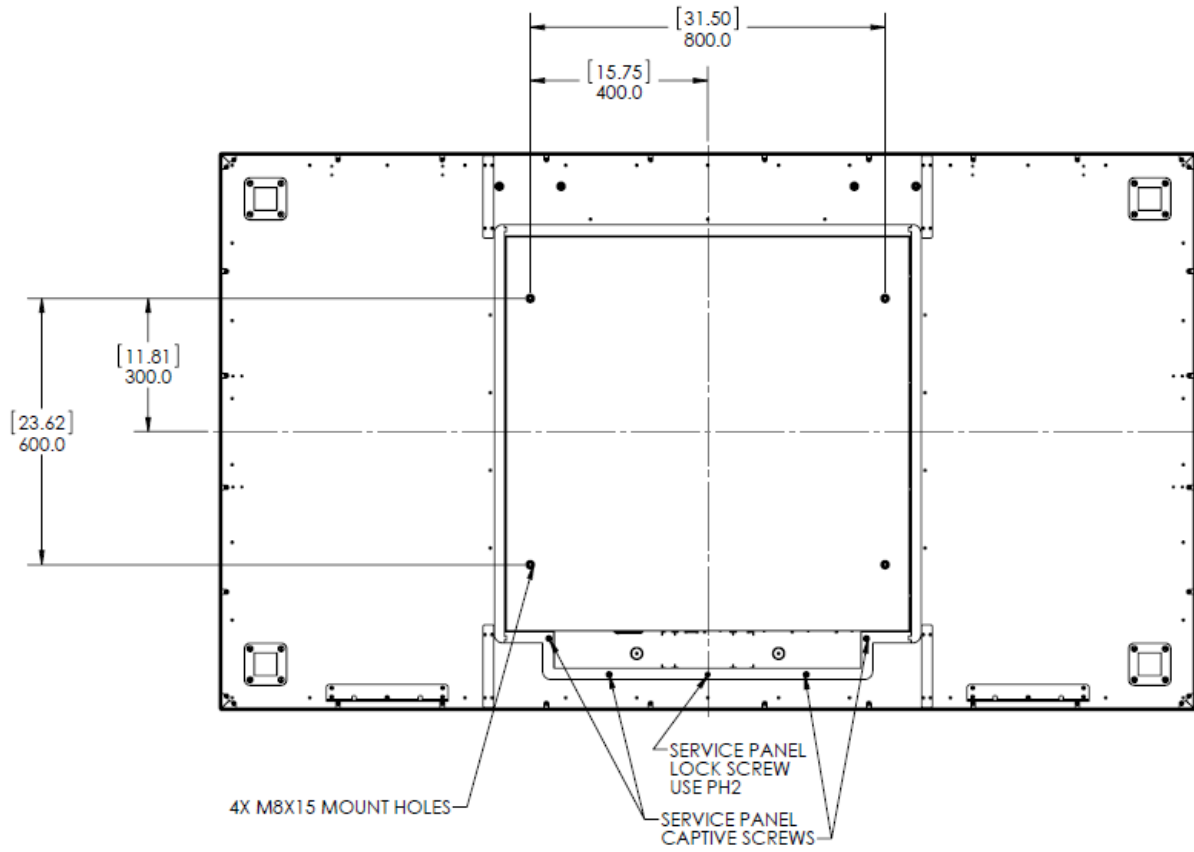

98" Rear View - Wall Mount Hangers and Service Panel Locations

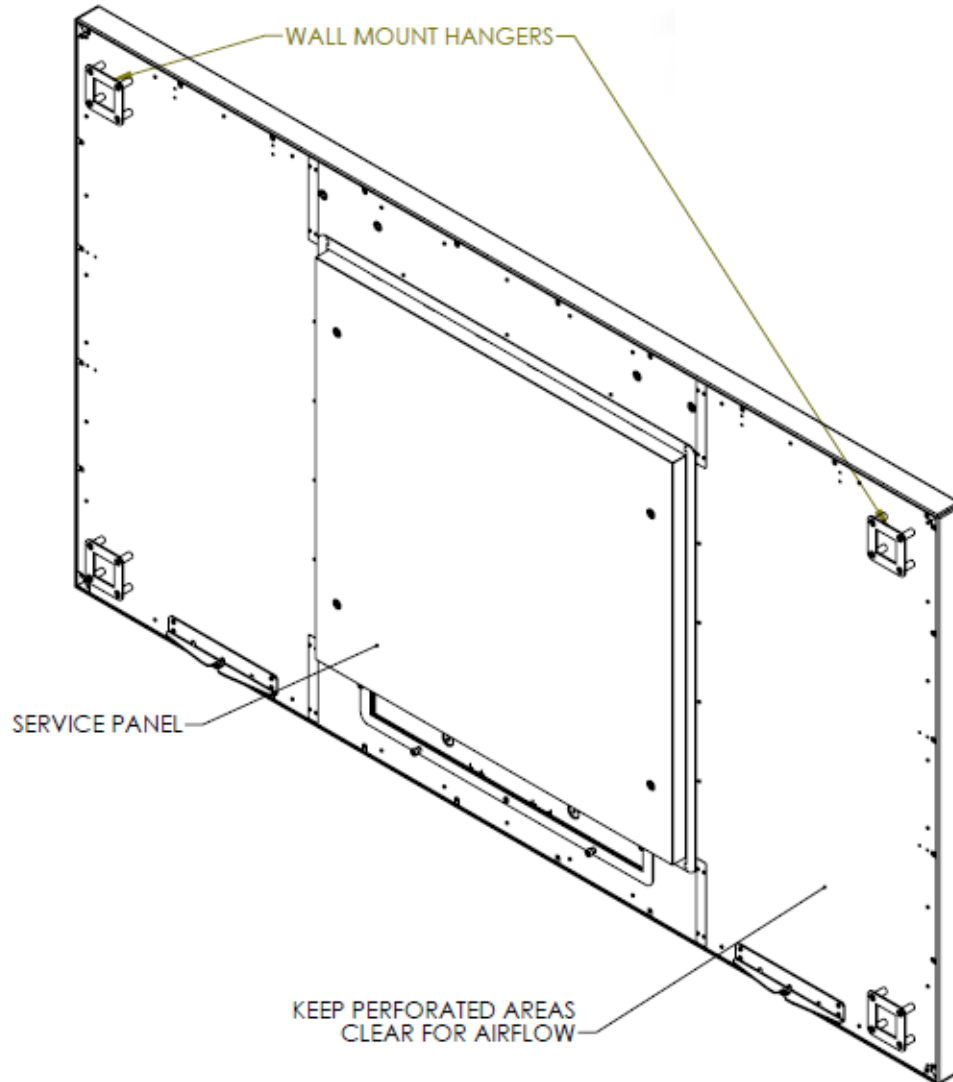

98" Landscape Wall Mounts - Front and Bottom Views

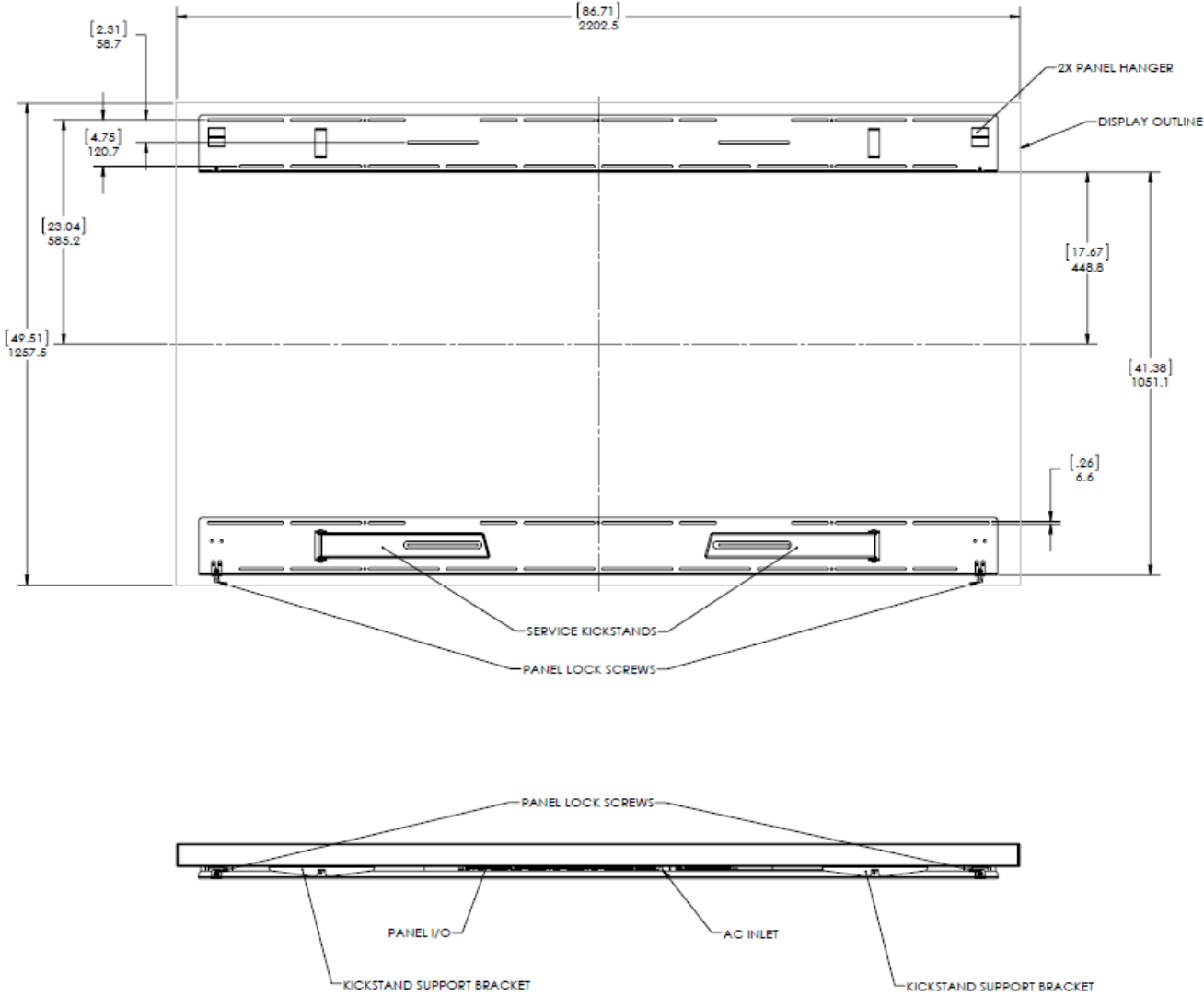

Note: Shown from the bottom of the panel.

98" Landscape Wall Mounts - Sides Views

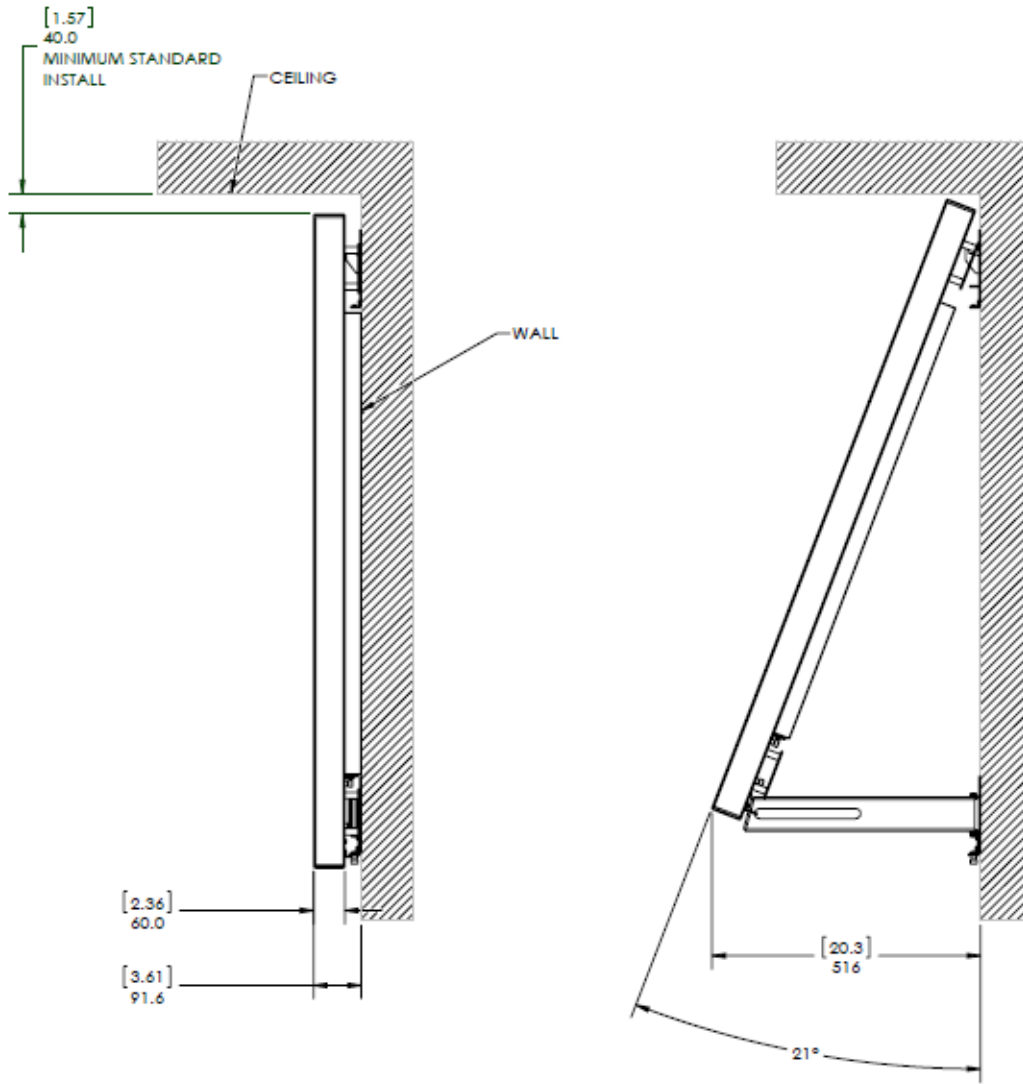

98" UltraRes Touch - Front, Top and Bottom Views

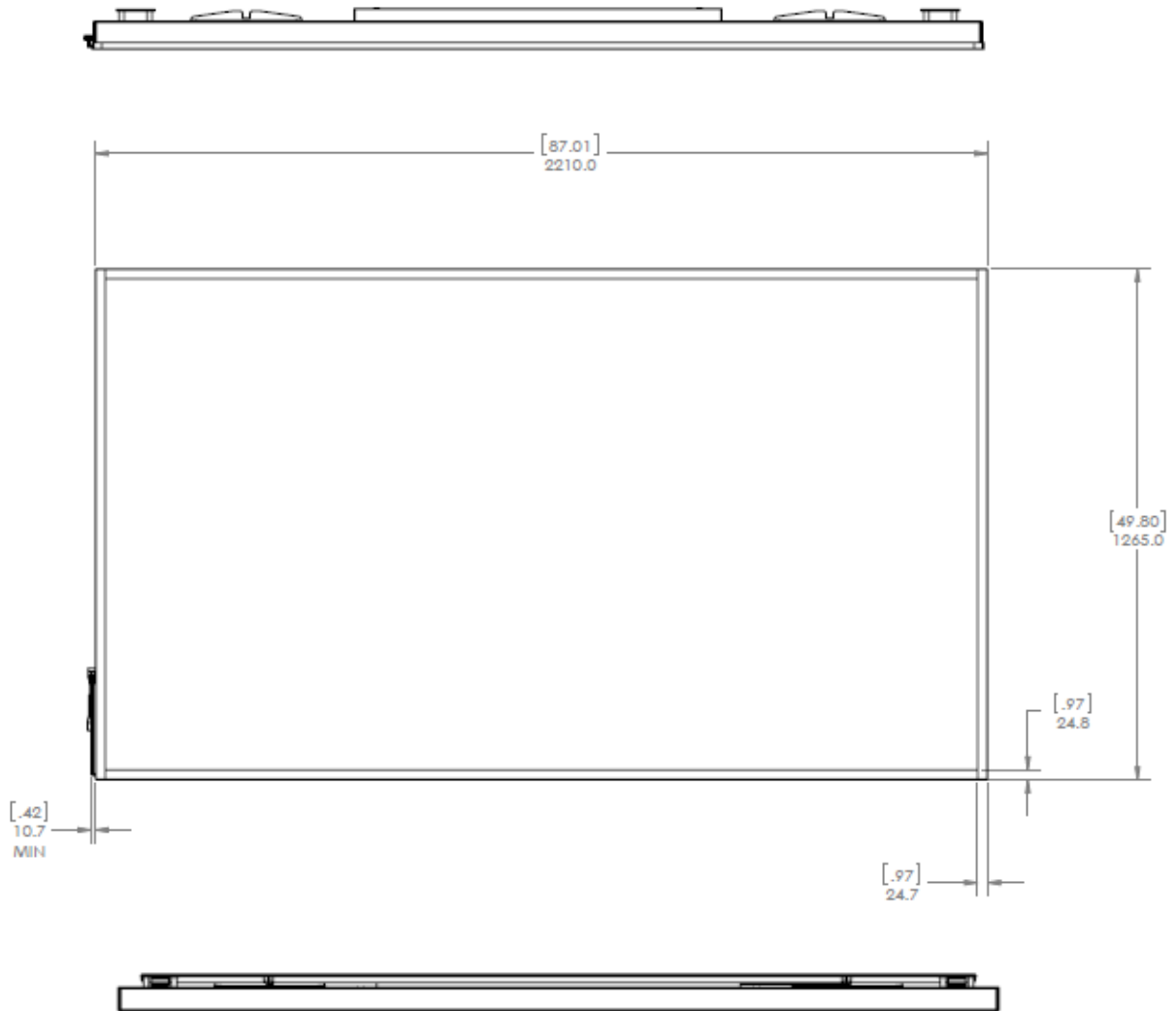

98" UltraRes Touch - Side Views

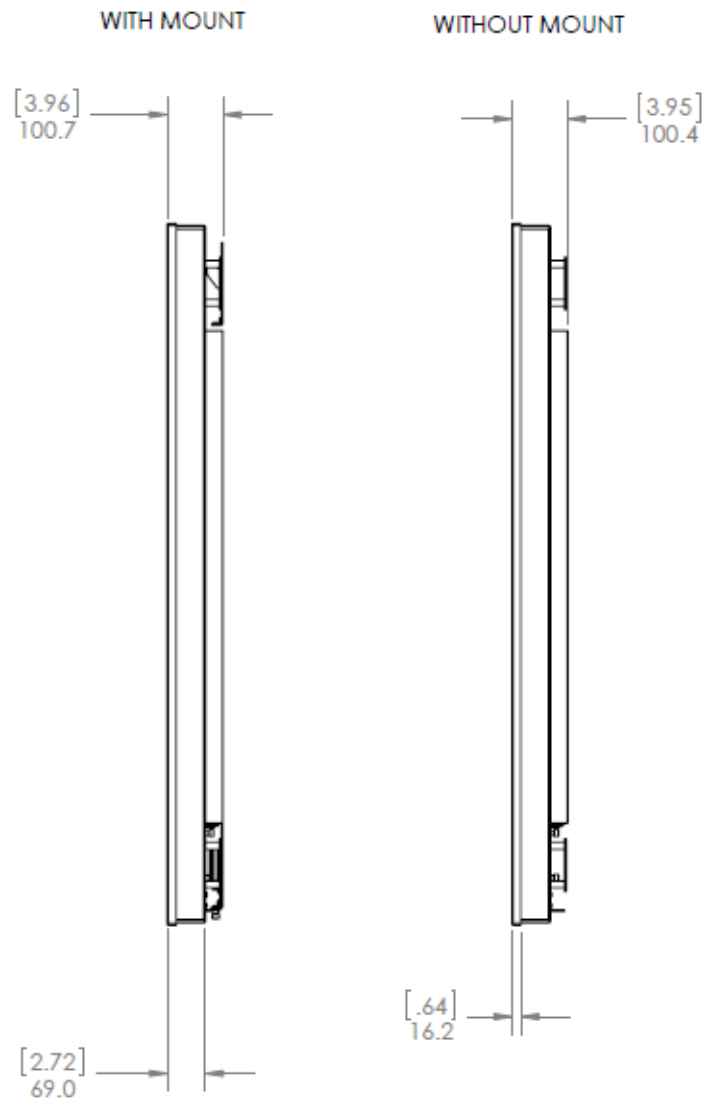

98" UltraRes Touch - Rear View

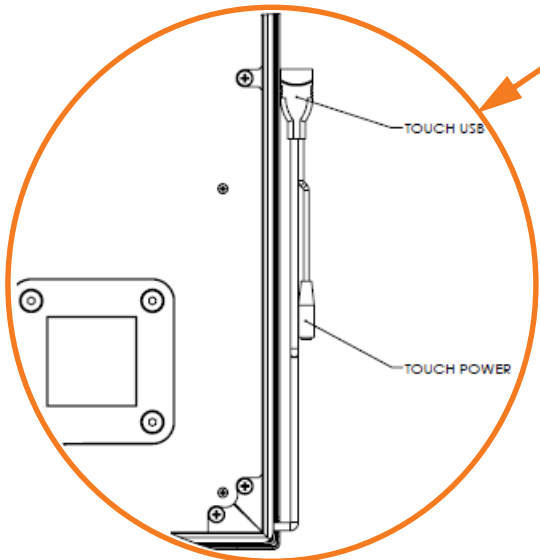
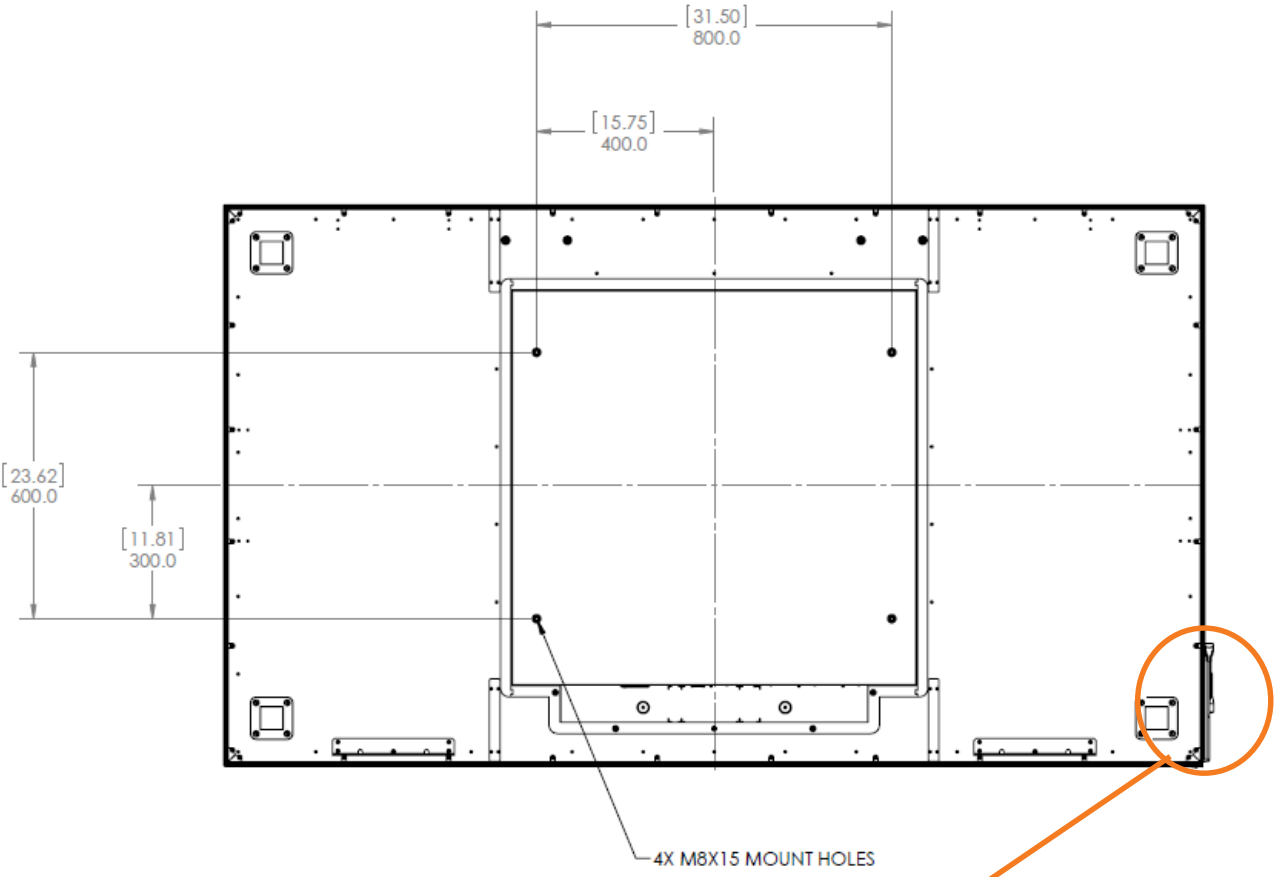

Troubleshooting During Installation

This section includes troubleshooting information about different issues you may encounter during the installation process or after your display has been running for some time. If you are not able to solve your issue in this section, please contact Planar's Technical Support team for assistance.

UltraRes LED Codes

The LED on the UltraRes display will show different things, depending on the state of the display.



System State	LED Behavior
Power Up	LED blinks on and off every ½ sec until it enters the ON state.
Standby	After the LED is powered on, the LED will be blue while in Standby mode.
Error	LED blinks on for 2 seconds and off for 4 seconds.
Firmware Upgrade	LED blinks on for 1 second and off for 1 second.
On	LED is off.

Error Codes in the UltraRes Control Software

To see the last 50 errors that have occurred, select the Error Log tab in the UltraRes Control software, as shown below. For a complete list of the error codes that may appear in the error log, see the table below.

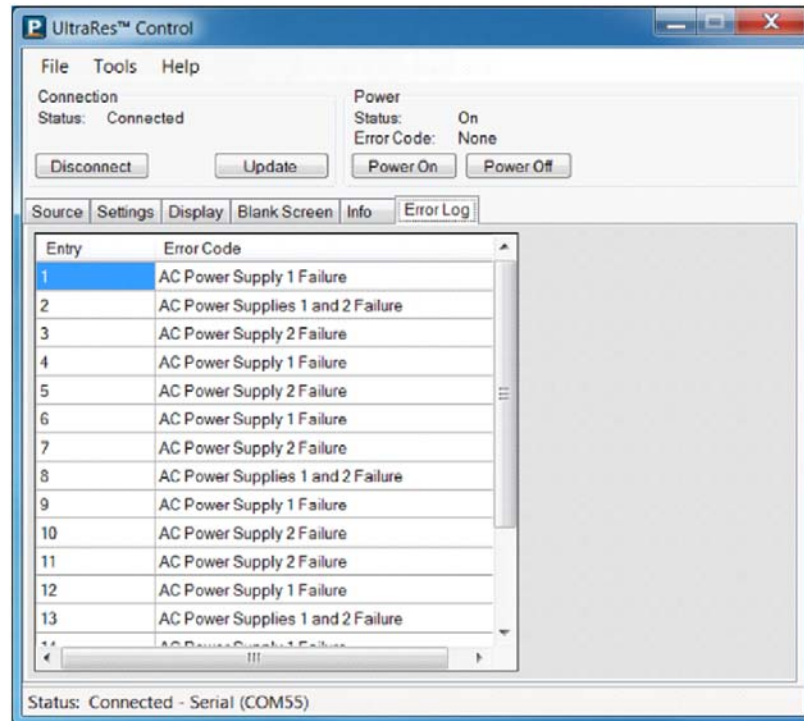

Error Code	Meaning	Display Behavior and Solution
AC Power Supply 1 Failure	One of the two AC power supplies is not working properly.	The backlight will be dimmed to a maximum setting of 10, which is necessary in order to reduce power consumption. Solution: Replace the failing power supply.
AC Power Supply 2 Failure		
AC Power Supplies 1 and 2 Failure	Both power supplies are not working.	The issue could be either the AC power supplies or the standby power board. Solution: First check the AC power status cable to make sure it's connected. Solution: If you have checked the connections and both power supplies are still not working, we recommend replacing the entire power tray.

Error Code	Meaning	Display Behavior and Solution
DC Power Supply Failure	One of the DC-DC converters on the main board of the display has failed.	The display will not start up if this occurs. Solution: The main board needs to be replaced.
FPGA Initialization Failure	One of the FPGAs on the main board did not start up correctly.	There are two possible causes: one of the FPGAs has corrupt code or is damaged. Solution: First check the FPGA status LEDs on the main board. If one is not blinking, that FPGA didn't start up. The FPGA code may need to be programmed again. Solution: If reprogramming an FPGA doesn't work, it is likely the FPGA is damaged. If this is the case, the main board needs to be replaced.
Calibration EEPROM Failure	The main board could not communicate with the calibration EEPROM.	It is likely that the calibration EEPROM cable is disconnected. Solution: Connect the EEPROM cable.

Symptoms, Possible Causes and Solutions

Below are different symptoms that you might encounter as you install your UltraRes display. First look at the different symptoms to see if you can find your issue. And then look at the possible cause and try the suggested solution(s). If you still are not able to resolve your issue, please contact Planar's Technical Support Department.

Symptom: Can't Get PC to Output 4K @ 24/30Hz

Possible Cause

Your graphics card may not support a 4K output.

Solution

Make sure that your graphics card can support a 4K output. See "Supported Graphics Cards" on page 20 for a list of the current graphics cards that Planar supports for the UltraRes display.

Solution

Confirm that you are using a DisplayPort output. You can't use a DisplayPort-to-HDMI adapter to output 4K content.

Solution

Make sure you are using a high-speed HDMI cable. Standard HDMI cables might work but are not guaranteed.

Solution

Verify that the selected **EDID Type** radio button in the UltraRes Control software is **4K Preferred**. If you change the EDID setting, you may need to disconnect and reconnect the cable.

Note: You can also change the **EDID Type** setting on the Advanced Setup page of the Remote Monitoring software.

Symptom: Can't Get PC to Output 4K @ 60Hz

Solution

Change the Input Source setting to one of the other quadrant inputs. For example, if you are using HDMI 1-4 and the current Input Source is HDMI 1, change it to HDMI 2.

Possible Cause

The connector overmold is too large, which can cause the pins not to contact properly on some cards.

Solution

If using DisplayPort, make sure the connector overmold isn't too large.



Symptom: My Scheduled Network Power On/Off Settings Aren't Working

Possible Cause

The Standby Mode setting in the UltraRes Control software may not be set to Fast Startup. If the Standby Mode is not set to Fast Startup, the LAN module power will be disabled in standby. Also, when the scheduler powers off the system, it won't be able to power back on later if Standby Mode is set to Low Power.

Solution

Make sure Standby Mode is set to Fast Startup in the UltraRes Control software. See "Standby Mode" on page 68 for more information.

Symptom: IR Isn't Working Properly

Possible Cause

The wired IR module may not be fully connected.

Solution

Make sure the IR is fully connected by pressing hard to ensure it is inserted as far as possible.

Possible Cause

The wired IR module cable is not being used.

Solution

Make sure that the wired IR module cable is used. See "Connecting the Wired IR Module" on page 39 for more information.



Accessing Planar's Technical Support Website

- 1 Go to <http://partners.planarcontrolroom.com>
- 2 Once you enter your login and password, you can access downloadable utility software, new firmware, user manuals, and service manuals.

Downloading Additional Documentation and Firmware

Some of the other documents for the UltraRes 4K professional display, which are or will be available on www.planar.com.

Downloading Utility Software

- 1 Go to <http://partners.planarcontrolroom.com>.
 - 1 Enter your login and password information.
 - 2 Navigate to the section that contains software updates and then look for Planar UltraRes.
 - 3 From the list of available software, click on the tool you need.

Regulatory Information

Manufacturer's Name: Planar Systems, Inc.
Manufacturer's Address: 1195 NW Compton Drive
Beaverton, OR 97006

Declares that the products Model Numbers: Planar UR8450-LX, UR8450-MX, UR9850

Conforms with the provisions of:

Council Directive 2004/108/EC on Electromagnetic Compatibility;

EN55022:2010 Radiated and Conducted Emissions from IT Equipment

EN55024:2010 Immunity of IT Equipment

Including:

EN61000-4-2	Electrostatic Discharge
EN61000-4-3	Radiated Immunity
EN61000-4-4	Electrical Fast Transients
EN61000-4-5	Line Surge
EN61000-4-6	RF Conducted Susceptibility
EN61000-4-8	Magnetic Field Immunity
EN61000-4-11	Voltage Dips and Interrupts

And:

EN61000-3-2	Harmonic Current Emissions
EN61000-3-3	Voltage fluctuations and Flicker

Council Directive 2006/95/EC on Low Voltage Equipment Safety:

EN60950:2006+A11+A1+A12 Safety of IT Equipment

The Technical Construction File required by this Directive is maintained at the corporate headquarters of Planar Systems, Inc., 1195 NW Compton Drive, Beaverton, OR 97006.

Note: This equipment has been tested and found to comply with the limits for a Class A digital device, pursuant to part 15 of the FCC Rules. These limits are designed to provide reasonable protection against harmful interference when the equipment is operated in a commercial environment. This equipment generates, uses, and can radiate radio frequency energy and, if not installed and used in accordance with the instruction manual, may cause harmful interference to radio communications. Operation of this equipment in a residential area is likely to cause harmful interference in which case the user will be required to correct the interference at his own expense.

Industry Canada (ICES-003): This Class A digital apparatus complies with Canadian ICES-003.

Cet appareil numérique de la classe A est conforme à la norme NMB-003 du Canada.

Any changes or modifications to the display not expressly approved by Planar could void the user's authority to operate this equipment.

Other Certifications

CISPR 22

Index

Numbers

4K from MacBooks, 44
4k not working, 145

A

access control in remote monitoring, 96
accessories
 accessory kit contents, 26
 checking, 24
 checking and unpacking, 24
 electronics box contents, 24
 LCD module box contents, 24
adjustment, order of, 70
admin setup in remote monitoring, 93
ambient operating temperature, 119
AMD graphics card setup, 51
aspect ratio, 117
auto power off timer, 68
auto power on/off, 68
avoiding temporary image retention, 12

B

backlight intensity, changing, 75
barometric pressure, 119
baud rate, 96
brightness
 control, 70
 screen, 118

C

certifications, 148
changing backlight intensity, 75
changing frame delay, 76
cleaning the LCD screen, 19
codes, error, 142
codes, LED, 141
color gamut, LCD module, 118
color temperature, 71
communicating via RS232 commands, 100

compatible video sources, 120
conformity information, 148
connecting
 RS232 cable, 100
 UltraRes control software, 67
connecting, IR sensor, 39
contrast control, 70
control, external, 99
controlling display via remote monitoring, 89
cooling requirements, 19
custom commands for Remote Monitoring, 87

D

date, changing in remote monitoring, 95
DHCP network setup, 80
dimensions, 123
 display front and side, 123, 133
 display front, top and bottom, 130, 138
 display rear, 124, 132, 134, 140
 display side, 131, 139
 LCD module, 117
dimming, local, on/off, 75
display
 basics, 14
 dimensions
 front and side, 123, 133
 front, top and bottom, 130, 138
 rear, 124, 132, 134, 140
 side, 131, 139
 installing, 28
drawings, 123
driver, MultiTouch, installing, 114

E

EDID type, 72
equipment list, 19
error codes, 79, 142
error log, 79
external control, 99

F

fast startup power, 68
 firmware, upgrading, 77
 frame delay, changing, 76
 frame tearing, fixing, 76

G

gain, 73
 gamma, 71, 73
 graphics card setup
 AMD, 51
 NVIDIA, 53

H

HDMI 3D frame packing, 72
 humidity, 119

I

input setup, 18
 installation
 before you build, 28
 of display on a wall, 29
 of LCD, 28
 of video wall, 19
 planning, 19
 space requirements, 19
 UltraRes control software, 61
 USB drivers for UltraRes control, 64
 IR codes, using, 112
 IR commands
 for UltraRes, 113
 protocol, 112
 IR not working, 146
 IR sensor, connecting, 39

K

kickstand bracket
 for LCD mounts, 25
 using, 38

L

landscape wall mounts
 front view, 126, 136
 side views, 127, 137
 LCD
 installation, 28
 mounts, 24
 optical specifications, 118
 wipes, 19
 LCD module, 24
 contents in box, 24
 dimensions, 117
 operating temperature, 119
 orientation, 117
 screen brightness, 118
 specifications, 117
 uniformity, 118
 viewing angle, 118
 LED behavior, 141
 LED codes, 141
 local dimming on/off, 75
 local dimming, turning on/off, 75
 low power standby mode, 68

M

MacBooks, 4K from, 44
 manufacturer's address, 148
 mechanical specifications, 117
 monitoring SNMP, 110
 mounting template for LCD mounts, 24
 multiple inputs
 setting up via RS232 commands, 100
 supported formats, 18
 MultiTouch
 driver installation, 114
 uninstalling the driver, 115

N

native resolution, 118
 network access, controlling in remote monitoring, 96
 network power on/off not working, 146
 network settings
 DHCP setup, 80
 static IP network setup, 82
 network setup in remote monitoring, 94

normal use thermal guidelines, 13
 NVIDIA graphics card setup, 53

O

offset, 74
 operating temperature, 119
 optical specifications, 118
 optional
 kickstand bracket, 25
 LCD mounts, 24
 mounting template, 24
 using the kickstand bracket, 38
 order of adjustment, 70
 orientation of LCD module, 117

P

PC not outputting 4K@60Hz, 145
 planning your installation, 19
 portrait wall mounts front view, 128, 129
 power
 off auto timer via UltraRes control, 68
 off display via UltraRes control, 16
 on/off for remote monitoring, 90
 power auto on/off, 68
 power on/off via network not working, 146
 PQLabs touchscreen, 115
 pressure, barometric, 119

R

rebooting remote monitoring, 98
 recommended usage, 12
 regulatory information, 148
 remote monitoring, 86
 Access control, 96
 admin setup, 93
 advanced setup, 92, 93
 Custom Commands, 87
 custom commands setup, 93
 date and time, 95
 display control, 89
 home, 86
 network setup, 94
 power on/off, 90
 rebooting the system, 98
 software setup, 97

 source setup, 91
 Unit Status, 88
 resolution, of LCD module, 118
 RS232
 command formats, 102
 command/response examples, 104
 commands, 102
 communication, 100
 connecting the cable, 100
 response formats, 103
 sending commands via UDP, 111
 setting up multiple inputs, 100
 setting up single inputs, 101
 supported UltraRes commands, 105

S

safety
 information, 9
 instructions, 9
 screen
 brightness, 118
 touch, setting up, 114
 service plans, ii
 setting up
 baud rate, 96
 inputs, 18
 multiple inputs, 100
 network, in remote monitoring, 94
 single inputs, 101
 software, in remote monitoring, 97
 sources via UltraRes control, 67
 touchscreen, 114
 setting up sources, 67
 signal compatibility, for UltraRes display, 120
 single inputs
 setting up via RS232 commands, 101
 SNMP monitoring, 110
 software, installing UltraRes Control, 61
 sources, setting up, 67
 space requirements, 19
 space requirements for installation, 19
 specifications
 environmental, 119
 LCD module, 117
 LCD optical, 118
 mechanical, 117
 splash screen, 69
 standby mode, 68

- fast startup power, 68
- low power, 68
- static IP network setup, 82

T

- temperature
 - operating, 119
 - requirements for normal use, 13
- temporary image retention
 - avoiding, 12
 - definition, 12
- thermal guidelines, 13
- time, changing in remote monitoring, 95
- TIR *see temporary image retention*
- tools/equipment list, 19
- touchscreen
 - PQLabs, 115
- touchscreen setup, 114
- touchscreen, driver installation, 114
- troubleshooting, 141
 - during installation, 141
 - error codes in UltraRes control software, 142
 - symptoms, 144

U

- UltraRes control
 - connection status, 67
 - error codes, 79
 - installing software, 61
 - installing USB drivers, 64
 - powering on/off display, 16
 - setting up
 - sources, 67
 - troubleshooting via error codes, 142
- UltraRes display
 - basics, 14
 - compatible signals, 120
 - installing on a wall, 29
 - supported RS232 commands, 105
- uniformity, 118
- uninstalling MultiTouch driver, 115
- unit status for Remote Monitoring, 88
- unpacking accessories, 24
- upgrading firmware, 77
- upgrading firmware via UltraRes control software, 77
- usage information, 12

- USB drivers, installing, 64
- using the kickstand bracket, 38

V

- ventilation requirements, 19
- viewing angle, 118

W

- wall mounts
 - landscape front view, 126, 136
 - landscape side views, 127, 137
 - portrait front view, 128, 129
- warranty information, ii
- web access, controlling in remote monitoring, 96
- weight, LCD module, 117